

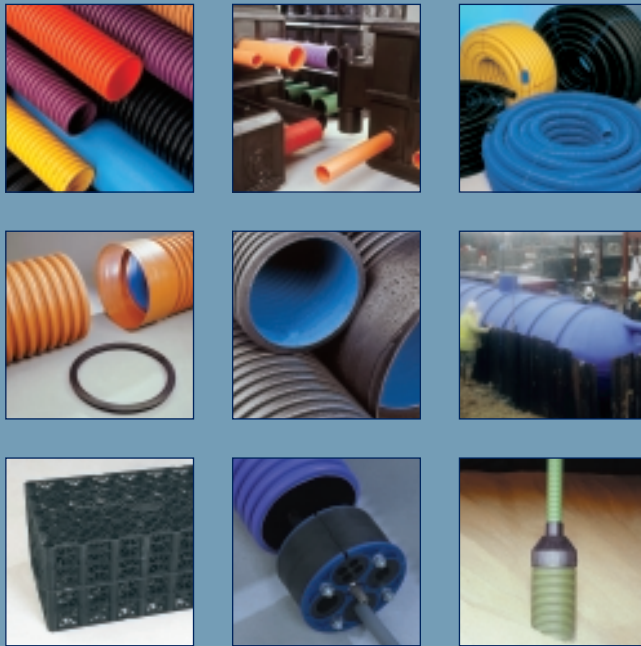

price list



www.polypipcivils.co.uk

Effective 9<sup>th</sup> January 2006

## INTRODUCTION

Polypipe Civils Limited is firmly established as the UK's leading supplier of ducting, drainage and environmental systems to the utilities, construction, civil engineering and agricultural industries.

Our highest priority is the innovation and development of new and existing products with a continued dedication to the highest standards of quality and customer service. Large research and development and technical support teams have been put in place to support the launch of an ever increasing number of new products to the industry.

## IMPORTANT CHANGES FROM CAP20

With effect from CAP21, price increases on all products effective from 9th January 2006.

The delivery estimates given in the price list are for guidance only. For exact delivery dates, please confirm with our Sales Department at the time of order.

Please note the introduction of Yellow Gas Duct to the Polypipe Civils range.

As part of our ongoing product review, some of our slower moving items may have been removed from the price list. Please contact our Sales Department if you have an enquiry for a product which is no longer listed.

## TABLE OF CONTENTS

### SEWERAGE SYSTEMS

|                        |                  |    |
|------------------------|------------------|----|
| <b>Gravity Systems</b> | Ridgisewer       | 11 |
|                        | Ridgitite Saddle | 13 |
|                        | Polysewer        | 15 |

### SURFACE WATER DRAINAGE

|                |                                     |    |
|----------------|-------------------------------------|----|
| <b>Carrier</b> | Ridgidrain Advanced Drainage System | 1  |
|                | Ridgigully and Accessories          | 7  |
|                | Ridgisewer                          | 11 |
| <b>Filter</b>  | Ridgidrain Advanced Drainage System | 1  |
|                | Fin & Narrow Filter Drains          | 10 |
|                | Fieldcoil & Landcoil                | 30 |
|                | Ridgitite Saddle                    | 13 |

### AGRICULTURAL PRODUCTS

|                      |               |    |
|----------------------|---------------|----|
| <b>Land Drainage</b> | Agritwin Pipe | 34 |
|                      | Fieldcoil     | 30 |
|                      | Landcoil      | 31 |
| <b>Miscellaneous</b> | Polydry       | 32 |

### ANCILLARY PRODUCTS

|                            |    |
|----------------------------|----|
| Lubricant                  | 10 |
| High Visibility Fencing    | 33 |
| Cable Guards               | 33 |
| Service Protection Markers | 33 |

### DUCTING SYSTEMS

|                  |                                 |    |
|------------------|---------------------------------|----|
| <b>Ridgiduct</b> | Important notes                 | 17 |
|                  | Electric Cable Duct             | 17 |
|                  | Motorway Comms Duct             | 17 |
|                  | Comtite Duct Transit System     | 19 |
|                  | Orange Lighting                 | 19 |
|                  | Utility Ducting                 | 19 |
|                  | Scottish Street Lighting        | 20 |
|                  | Fittings                        | 20 |
| <b>Polyduct</b>  | Electric Cable Duct             | 21 |
|                  | Orange Lighting                 | 22 |
| <b>Ridgicoil</b> | Black Electric Cable Duct       | 22 |
|                  | Purple Motorway Comms Duct      | 23 |
|                  | Orange Lighting                 | 23 |
|                  | Utilities                       | 23 |
|                  | Fittings                        | 24 |
| <b>uPVC</b>      | uPVC Specification Ducting      | 24 |
|                  | uPVC General Purpose Ducting    | 25 |
|                  | Suretwin Twin Wall Ducting      | 26 |
|                  | Yellow Perforated Gas Duct      | 26 |
|                  | uPVC Utility / Cable TV Ducting | 27 |
|                  | Duct Repair Kit                 | 28 |
|                  | Hockey Sticks                   | 28 |
|                  | Ducted Access Systems           | 28 |

### ENVIRONMENTAL PRODUCTS

|                                      |    |
|--------------------------------------|----|
| Eco-Vat Rainwater Harvesting Systems | 34 |
| Polystorm System                     | 9  |
| Stormcheck Chambers                  | 9  |

**RIDGIDRAIN ADVANCED DRAINAGE SYSTEM**

**ESTIMATOR'S GUIDE**

**Plain Ended Carrier Drain in 6 metre lengths**

| Nominal Size (mm) | Price per metre |
|-------------------|-----------------|
| 100               | 4.23            |
| 150               | 7.26            |
| 225               | 17.78           |
| 300               | 28.25           |
| 375               | 58.19           |
| 400               | 73.87           |
| 450               | 82.21           |
| 500               | 97.65           |
| 600               | 128.80          |
| 750               | 190.17          |
| 900               | 302.78          |
| 1050              | 411.80          |

Includes one coupling and 2 seals.

**Plain Ended Filter Drain in 6 metre lengths**

| Nominal Size (mm) | Fully perforated Price per metre | Half-perforated Price per metre |
|-------------------|----------------------------------|---------------------------------|
| 100               | 4.22                             | 4.55                            |
| 150               | 6.92                             | 7.80                            |
| 225               | 17.27                            | 19.18                           |
| 300               | 27.64                            | 30.45                           |
| 375               | 57.40                            | 62.85                           |
| 400               | 70.11                            | 75.64                           |
| 450               | 73.30                            | 79.42                           |
| 500               | 97.52                            | 107.87                          |
| 600               | 129.24                           | 144.47                          |
| 750               | 180.93                           | 203.16                          |
| 900               | 292.40                           | 322.04                          |
| 1050              | 400.90                           | 331.91                          |

Includes one coupling for fully perforated pipe and one coupling and 2 seals for half-perforated pipe where seals are specified.

For half-perforated pipes where seals are not specified the fully perforated price should be used.

**Integrally Socketed Carrier Drain**

| Nominal Size (mm) | Length (m) | Price per metre |
|-------------------|------------|-----------------|
| 400               | 6          | 70.59           |
| 450               | 6          | 77.46           |
| 500               | 6          | 92.83           |
| 600               | 6          | 122.38          |
| 750               | 3          | 169.86          |
| 900               | 3          | 286.00          |

Includes integral coupling and one seal.

**Integrally Socketed Filter Drain**

| Nominal Size (mm) | Length (m) | Fully perforated Price per metre | Half-perforated Price per metre |
|-------------------|------------|----------------------------------|---------------------------------|
| 400               | 6          | 74.14                            | 76.90                           |
| 450               | 6          | 78.08                            | 81.14                           |
| 500               | 6          | 92.02                            | 97.19                           |
| 600               | 6          | 120.48                           | 128.10                          |
| 750               | 3          | 155.00                           | 177.22                          |
| 900               | 3          | 268.34                           | 297.98                          |

Includes integral coupling for fully perforated pipe and integral coupling and one seal for half-perforated pipe where seals are specified.

For half-perforated pipes where seals are not specified the fully perforated price should be used.

**Ridgidrain Pack Quantities**

| Nominal Size (mm) | Quantity |
|-------------------|----------|
| 100               | 85       |
| 150               | 36       |
| 225               | 14       |
| 300               | 9        |
| 375               | 5        |
| 400               | 5        |
| 450               | 1        |
| 500               | 1        |
| 600               | 1        |
| 750               | 1        |
| 900               | 1        |
| 1050              | 1        |

Pipes, couplings and seals will be invoiced separately.



**RIDGIDRAIN ADVANCED DRAINAGE SYSTEM**

**Plain Ended Carrier Drain in 6 metre lengths**

| Description   | Nom. Size | ID(mm) | OD(mm) | Code       | Pack quantity | Price per length | Price per metre |
|---|-----------|--------|--------|------------|---------------|------------------|-----------------|
| <b>HDPE Carrier Drain</b><br><br>Order Seals and Couplings separately if required.          | 100       | 100    | 118    | RD100X6PE  | 85            | 20.09            | 3.35            |
|   | 150       | 150    | 178    | RD150X6PE  | 36            | 32.75            | 5.46            |
|   | 225       | 225    | 266    | RD225X6PE  | 14            | 83.88            | 13.98           |
|   | 300       | 300    | 354    | RD300X6PE  | 9             | 131.82           | 21.97           |
|   | 375       | 375    | 435    | RD375X6PE  | 5             | 279.54           | 46.59           |
| <b>Polypropylene Carrier Drain</b><br><br>Order Seals and Couplings separately if required. | 400*      | 400    | 460    | RD400X6PE  | 5             | 368.88           | 61.48           |
|   | 450*      | 450    | 514    | RD450X6PE  | 1             | 407.04           | 67.84           |
|   | 500*      | 500    | 571    | RD500X6PE  | 1             | 451.15           | 75.19           |
|   | 600*      | 592    | 675    | RD600X6PE  | 1             | 580.63           | 96.77           |
|   | 750*      | 766    | 883    | RD750X6PE  | 1             | 779.53           | 129.92          |
|   | 900*      | 914    | 1040   | RD900X6PE  | 1             | 1353.99          | 225.66          |
|   | 1050*     | 1065   | 1215   | RD1050X6PE | 1             | 1948.92          | 324.82          |



150 to 900mm



100 to 900mm



**Plain Ended Filter Drain in 6 metre lengths**

| Description   | Nom. Size | ID(mm) | OD(mm) | Code                | Pack quantity | Price per length | Price per metre |
|---|-----------|--------|--------|---------------------|---------------|------------------|-----------------|
| <b>HDPE Filter Drain</b><br><br>State fully or half-perforated as required and adjust codes as noted. P = Perforated<br>HP = Half-Perforated                            | 100       | 100    | 118    | RD100X6PE P or HP*  | 85            | 21.96            | 3.66            |
|   | 150       | 150    | 178    | RD150X6PE P or HP*  | 36            | 36.03            | 6.01            |
|   | 225       | 225    | 266    | RD225X6PE P or HP*  | 14            | 92.24            | 15.37           |
|   | 300       | 300    | 354    | RD300X6PE P or HP*  | 9             | 145.01           | 24.17           |
|   | 375       | 375    | 435    | RD375X6PE P or HP*  | 5             | 307.48           | 51.25           |
| <b>Polypropylene Filter Drain</b><br><br>State fully or half-perforated as required and adjust codes as noted.<br><br>Order Seals and Couplings separately if required. | 400       | 400    | 460    | RD400X6PEP          | 5             | 379.48           | 63.25           |
|   | 450       | 450    | 514    | RD450X6PEP          | 1             | 390.26           | 65.04           |
|   | 500       | 500    | 571    | RD500X6PEP          | 1             | 512.50           | 85.42           |
|   | 600       | 592    | 675    | RD600X6PEP          | 1             | 674.65           | 112.44          |
|   | 750       | 766    | 883    | RD750X6PEP          | 1             | 857.46           | 142.91          |
|   | 900       | 914    | 1040   | RD900X6PEP          | 1             | 1469.53          | 244.92          |
|   | 1050      | 1065   | 1215   | RD1050X6PE P or HP* | 1             | 2113.98          | 352.33          |

P = Perforated HP = Half-Perforated HP\* = Made to Order

**Integrally Socketed Polypropylene Carrier Drain**

| Description  | Nom. Size | ID(mm) | OD(mm) | Code    | Pack quantity | Price per length | Price per metre |
|--|-----------|--------|--------|---------|---------------|------------------|-----------------|
| <b>Carrier Drain (6 metre lengths)</b><br><br>Price includes one integral socket.<br>Order Seals separately if required. | 400       | 400    | 460    | RD400X6 | 5             | 406.95           | 67.83           |
|  | 450       | 450    | 514    | RD450X6 | 1             | 446.41           | 74.40           |
|  | 500       | 500    | 571    | RD500X6 | 1             | 525.91           | 87.65           |
|  | 600       | 592    | 675    | RD600X6 | 1             | 688.54           | 114.76          |
| <b>Carrier Drain (3 metre lengths)</b><br><br>Price includes one integral socket.<br>Order Seals separately if required. | 750       | 766    | 883    | RD750X3 | 1             | 442.89           | 147.63          |
|  | 900       | 914    | 1040   | RD900X3 | 1             | 769.09           | 256.36          |

\* Check availability prior to order placement. Plain ended pipe.

PLEASE ALLOW 3 DAYS FOR DELIVERY

PLEASE ALLOW 7 DAYS FOR DELIVERY

MADE TO ORDER ONLY

**RIDGIDRAIN ADVANCED DRAINAGE SYSTEM**

**Integrally Socketed Polypropylene Filter Drain**



150 to 900mm

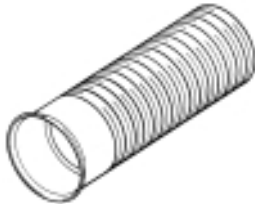

100 to 900mm

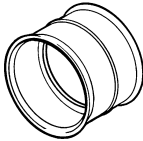

| Description                           | Nom. Size | ID(mm) | OD(mm) | Code             | Pack quantity | Price per length | Price per metre |
|---------------------------------------|-----------|--------|--------|------------------|---------------|------------------|-----------------|
| <b>Filter Drain (6 metre lengths)</b> | 400       | 400    | 460    | RD400X6 P or HP* | 5             | 444.84           | 74.14           |
|                                       | 450       | 450    | 514    | RD450X6 P or HP* | 1             | 468.50           | 78.08           |
|                                       | 500       | 500    | 571    | RD500X6 P or HP* | 1             | 552.12           | 92.02           |
|                                       | 600       | 592    | 675    | RD600X6 P or HP* | 1             | 722.87           | 120.48          |

|                                       |     |     |      |                  |   |        |        |
|---------------------------------------|-----|-----|------|------------------|---|--------|--------|
| <b>Filter Drain (3 metre lengths)</b> | 750 | 766 | 883  | RD750X3 P or HP* | 1 | 465.00 | 155.00 |
|                                       | 900 | 914 | 1040 | RD900X3 P or HP* | 1 | 805.03 | 268.34 |

Price includes one integral socket. Order seals separately if required.  
 State fully or half-perforated as required and adjust codes as noted.  
 P = Perforated HP = Half-Perforated **HP\* = Made to Order**

**Double Socket Couplings**

| Description  | Nom. Size(mm) | Code     | Pack Qty | Price (each) |
|--|---------------|----------|----------|--------------|
| <b>Double Socket Couplings</b><br><br>One Coupling and two Seals required per joint.<br>Seals supplied separately. | 100           | CRD100   | 43       | 3.38         |
|  | 150           | CRD150   | 18       | 5.50         |
|  | 225           | CRD225   | 7        | 11.37        |
|  | 300           | CRD300   | 3        | 20.86        |
|  | 375           | CRD375   | 1        | 36.91        |
|  | 400           | CRD400DS | 1        | 41.18        |
|  | 450           | CRD450DS | 1        | 49.57        |
|  | 500           | CRD500DS | 1        | 72.63        |
|  | 600           | CRD600DS | 1        | 100.76       |
|  | 750           | CRD750   | 1        | 228.15       |
|  | 900           | CRD900   | 1        | 284.88       |
|  | 1050          | CRD1050  | 1        | 291.43       |

**Sealing Rings**

| Description  | Nom. Size(mm) | Code    | Pack Qty | Price (each) |
|--|---------------|---------|----------|--------------|
| <b>Sealing Rings</b><br><br>EPDM Seals to BS EN681: Part 1 are standard.<br>Optional nitrile seals are available (BBA pending),<br>subject to lead times and order quantity. Add 15% to<br>the prices shown and state at time of enquiry or order. | 100           | SRD100  | 170      | 0.97         |
|  | 150           | SRD150  | 72       | 2.64         |
|  | 225           | SRD225  | 28       | 5.72         |
|  | 300           | SRD300  | 18       | 8.43         |
|  | 375           | SRD375  | 10       | 16.35        |
|  | 400           | SRD400  | 2        | 16.58        |
|  | 450           | SRD450  | 2        | 18.34        |
|  | 500           | SRD500  | 2        | 31.04        |
|  | 600           | SRD600  | 2        | 45.72        |
|  | 750           | SRD750  | 1        | 66.67        |
|  | 900           | SRD900  | 1        | 88.91        |
|  | 1050          | SRD1050 | 1        | 115.24       |



PLEASE ALLOW 3 DAYS FOR DELIVERY

PLEASE ALLOW 7 DAYS FOR DELIVERY

MADE TO ORDER ONLY

**RIDGIDRAIN ADVANCED DRAINAGE SYSTEM**

**Double Socketed Bends**

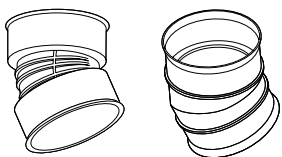
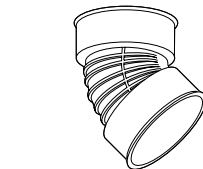
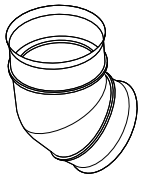
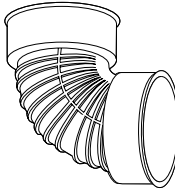
| Description  | Nom. Size(mm) | Code         | Pack Qty | Price (each) |
|--|---------------|--------------|----------|--------------|
| <b>11.25° Bends</b>  |               |              |          |              |
|  <p>150 to 900mm</p>   <p>100 to 900mm</p>  | 100           | BRD100X11.25 | 1        | 23.14        |
|  | 225           | BRD225X11.25 | 1        | 79.48        |
|  | 300           | BRD300X11.25 | 1        | 137.76       |
|  | 375           | BRD375X11.25 | 1        | 253.96       |
|  | 400           | BRD400X11.25 | 1        | 292.15       |
|  | 450           | BRD450X11.25 | 1        | 305.37       |
|  | 500           | BRD500X11.25 | 1        | 421.42       |
|  | 600           | BRD600X11.25 | 1        | 486.82       |
|  | 750           | BRD750X11.25 | 1        | 1208.72      |
|  | 900           | BRD900X11.25 | 1        | 1399.35      |
| 1050   | BRD1050X11.25 | 1            | 1686.54  |              |
| <b>Injection Moulded 15° Bend</b>  |               |              |          |              |
| 150  | BRD150X15     | 10           | 24.72    |              |
| <b>22.5° Bends</b>   |               |              |          |              |
|   | 100           | BRD100X22.5  | 1        | 23.14        |
|  | 225           | BRD225X22.5  | 1        | 79.48        |
|  | 300           | BRD300X22.5  | 1        | 137.76       |
|  | 375           | BRD375X22.5  | 1        | 253.96       |
|  | 400           | BRD400X22.5  | 1        | 292.15       |
|  | 450           | BRD450X22.5  | 1        | 305.37       |
|  | 500           | BRD500X22.5  | 1        | 421.42       |
|  | 600           | BRD600X22.5  | 1        | 486.82       |
|  | 750           | BRD750X22.5  | 1        | 1208.72      |
|  | 900           | BRD900X22.5  | 1        | 1399.35      |
| 1050   | BRD1050X22.5  | 1            | 1686.54  |              |
| <b>Injection Moulded 30° Bend</b>  |               |              |          |              |
| 150  | BRD150X30     | 10           | 25.01    |              |
| <b>Injection Moulded 45° Bends</b>   |               |              |          |              |
| 100  | BRD100X45     | 25           | 22.13    |              |
| 150  | BRD150X45     | 10           | 24.72    |              |
| <b>45° Bends</b>   |               |              |          |              |
|   | 225           | BRD225X45    | 1        | 79.48        |
|  | 300           | BRD300X45    | 1        | 137.76       |
|  | 375           | BRD375X45    | 1        | 253.96       |
|  | 400           | BRD400X45    | 1        | 292.15       |
|  | 450           | BRD450X45    | 1        | 305.37       |
|  | 500           | BRD500X45    | 1        | 421.42       |
|  | 600           | BRD600X45    | 1        | 486.82       |
|  | 750           | BRD750X45    | 1        | 1208.72      |
|  | 900           | BRD900X45    | 1        | 1399.35      |
|  | 1050          | BRD1050X45   | 1        | 1686.54      |
| <b>Injection Moulded 87.5° Bends</b>   |               |              |          |              |
| 100  | BRD100X87.5   | 15           | 22.13    |              |
| 150  | BRD150X87.5   | 10           | 24.72    |              |
| <b>90° Lobster Back Bends</b>  |               |              |          |              |
|   | 225           | BLBRD225X90  | 1        | 158.95       |
|  | 300           | BLBRD300X90  | 1        | 263.70       |
|  | 375           | BLBRD375X90  | 1        | 507.90       |
|  | 400           | BLBRD400X90  | 1        | 507.90       |
|  | 450           | BLBRD450X90  | 1        | 610.74       |
|  | 500           | BLBRD500X90  | 1        | 842.84       |
|  | 600           | BLBRD600X90  | 1        | 973.62       |
|  | 750           | BLBRD750X90  | 1        | 2657.46      |
|  | 900           | BLBRD900X90  | 1        | 3086.81      |
|  | 1050          | BLBRD1050X90 | 1        | 4166.16      |

PLEASE ALLOW 3 DAYS FOR DELIVERY

PLEASE ALLOW 7 DAYS FOR DELIVERY

MADE TO ORDER ONLY

**RIDGIDRAIN ADVANCED DRAINAGE SYSTEM**

**Junctions**

| Description | A(mm) | B(mm) | Code | Pack Qty | Price (each) |
|-------------|-------|-------|------|----------|--------------|
|-------------|-------|-------|------|----------|--------------|

**90° Bends**

Order seals if required.

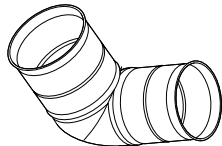

**Injection Moulded 45° Junctions**

Order Seals if required.

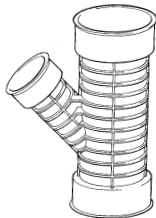

**45° Junctions**

Order Seals if required.

Key

A = Main bore

B = Branch



All junctions are triple socketed except 750, 900 and 1050mm.

Equal junctions in 750, 900 and 1050mm sizes are plain ended.

Unequal junctions in 750, 900 and 1050mm sizes are manufactured with a socket on the branch.

These junctions are made to order and subject to lead times.

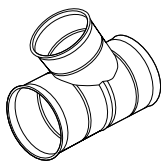

|      |      |              |    |         |
|------|------|--------------|----|---------|
| 225  | -    | BRD225X90    | 1  | 79.48   |
| 300  | -    | BRD300X90    | 1  | 137.76  |
| 375  | -    | BRD375X90    | 1  | 253.96  |
| 400  | -    | BRD400X90    | 1  | 292.15  |
| 450  | -    | BRD450X90    | 1  | 305.37  |
| 500  | -    | BRD500X90    | 1  | 421.42  |
| 600  | -    | BRD600X90    | 1  | 486.82  |
| 750  | -    | BRD750X90    | 1  | 1328.72 |
| 900  | -    | BRD900X90    | 1  | 1543.42 |
| 1050 | -    | BRD1050X90   | 1  | 2083.08 |
| 100  | 100  | JRD100100Y   | 10 | 32.54   |
| 150  | 100  | JRD150100Y   | 5  | 43.57   |
| 150  | 150  | JRD150150Y   | 5  | 43.57   |
| 225  | 150  | JRD225150Y   | 1  | 100.27  |
| 300  | 150  | JRD300150Y   | 1  | 130.37  |
| 225  | 100  | JRD225100Y   | 1  | 95.24   |
| 225  | 225  | JRD225225Y   | 1  | 161.03  |
| 300  | 100  | JRD300100Y   | 1  | 125.82  |
| 300  | 225  | JRD300225Y   | 1  | 289.34  |
| 300  | 300  | JRD300300Y   | 1  | 510.30  |
| 375  | 100  | JRD375100Y   | 1  | 205.13  |
| 375  | 150  | JRD375150Y   | 1  | 215.62  |
| 375  | 225  | JRD375225Y   | 1  | 296.29  |
| 375  | 300  | JRD375300Y   | 1  | 474.06  |
| 375  | 375  | JRD375375Y   | 1  | 597.12  |
| 400  | 150  | JRD400150Y   | 1  | 227.50  |
| 400  | 400  | JRD400400Y   | 1  | 599.15  |
| 450  | 100  | JRD450100Y   | 1  | 241.58  |
| 450  | 150  | JRD450150Y   | 1  | 242.56  |
| 450  | 225  | JRD450225Y   | 1  | 386.31  |
| 450  | 300  | JRD450300Y   | 1  | 419.35  |
| 450  | 450  | JRD450450Y   | 1  | 774.90  |
| 500  | 150  | JRD500150Y   | 1  | 325.40  |
| 500  | 225  | JRD500225Y   | 1  | 433.04  |
| 500  | 300  | JRD500300Y   | 1  | 474.06  |
| 500  | 500  | JRD500500Y   | 1  | 1084.89 |
| 600  | 100  | JRD600100Y   | 1  | 364.67  |
| 600  | 150  | JRD600150Y   | 1  | 349.37  |
| 600  | 225  | JRD600225Y   | 1  | 451.26  |
| 600  | 300  | JRD600300Y   | 1  | 1180.58 |
| 600  | 600  | JRD600600Y   | 1  | 1180.58 |
| 750  | 150  | JRD750150Y   | 1  | 907.49  |
| 750  | 750  | JRD750750Y   | 1  | 2963.15 |
| 900  | 150  | JRD900150Y   | 1  | 958.17  |
| 900  | 900  | JRD900900Y   | 1  | 3199.81 |
| 1050 | 150  | JRD1050150Y  | 1  | 1199.74 |
| 1050 | 1050 | JRD10501050Y | 1  | 4325.73 |

**Other specialist junctions  
maybe available on request.**

PLEASE ALLOW 3 DAYS FOR DELIVERY

PLEASE ALLOW 7 DAYS FOR DELIVERY

MADE TO ORDER ONLY

**RIDGIDRAIN ADVANCED DRAINAGE SYSTEM**

**Junctions**

| Description                            | A(mm) | B(mm) | Code         | Pack Qty | Price (each) |
|--|-------|-------|--------------|----------|--------------|
| <b>Injection Moulded 90° Junctions</b> |       |       |              |          |              |
| Order Seals if required.               | 100   | 100   | JRD100100T   | 10       | 32.54        |
|  | 150   | 100   | JRD150100T   | 10       | 43.57        |
|  | 150   | 150   | JRD150150T   | 1        | 43.57        |
| <b>90° Junctions</b>                   |       |       |              |          |              |
| Order Seals if required.               | 225   | 100   | JRD225100T   | 1        | 95.24        |
|  | 225   | 150   | JRD225150T   | 1        | 112.84       |
|  | 225   | 225   | JRD225225T   | 1        | 161.03       |
|  | 300   | 100   | JRD300100T   | 1        | 125.82       |
|  | 300   | 150   | JRD300150T   | 1        | 140.53       |
|  | 300   | 225   | JRD300225T   | 1        | 289.34       |
|  | 300   | 300   | JRD300300T   | 1        | 488.46       |
|  | 375   | 100   | JRD375100T   | 1        | 205.13       |
|  | 375   | 150   | JRD375150T   | 1        | 215.62       |
|  | 375   | 225   | JRD375225T   | 1        | 296.29       |
|  | 375   | 300   | JRD375300T   | 1        | 474.06       |
|  | 375   | 375   | JRD375375T   | 1        | 597.12       |
|  | 400   | 150   | JRD400150T   | 1        | 227.50       |
|  | 400   | 400   | JRD400400T   | 1        | 599.15       |
|  | 450   | 100   | JRD450100T   | 1        | 241.58       |
|  | 450   | 150   | JRD450150T   | 1        | 244.01       |
|  | 450   | 225   | JRD450225T   | 1        | 386.31       |
|  | 450   | 300   | JRD450300T   | 1        | 419.35       |
|  | 450   | 450   | JRD450450T   | 1        | 774.90       |
|  | 500   | 100   | JRD500100T   | 1        | 309.96       |
|  | 500   | 150   | JRD500150T   | 1        | 325.40       |
|  | 500   | 225   | JRD500225T   | 1        | 433.04       |
|  | 500   | 300   | JRD500300T   | 1        | 474.06       |
|  | 500   | 500   | JRD500500T   | 1        | 1084.86      |
|  | 600   | 100   | JRD600100T   | 1        | 364.67       |
|  | 600   | 150   | JRD600150T   | 1        | 349.37       |
|  | 600   | 225   | JRD600225T   | 1        | 451.26       |
|  | 600   | 300   | JRD600300T   | 1        | 1180.58      |
|  | 600   | 600   | JRD600600T   | 1        | 1180.58      |
|  | 750   | 150   | JRD750150T   | 1        | 876.91       |
|  | 750   | 750   | JRD750750T   | 1        | 2734.91      |
|  | 900   | 150   | JRD900150T   | 1        | 927.33       |
|  | 900   | 900   | JRD900900T   | 1        | 2976.06      |
|  | 1050  | 150   | JRD1050150T  | 1        | 1169.20      |
|  | 1050  | 1050  | JRD10501050T | 1        | 3938.29      |

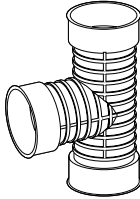

**Key**

A = Main bore  
B = Branch

All junctions are triple socketed except 750, 900 and 1050mm.

Equal junctions in 750, 900 and 1050mm sizes are plain ended.

Unequal junctions in 750, 900 and 1050mm sizes are manufactured with a socket on the branch. These junctions are made to order and subject to lead times.

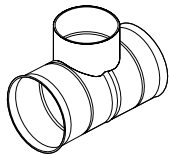

**Other specialist junctions maybe available on request.**

**GULLIES & ACCESSORIES**

**End Caps**

| Description                                     | Size (mm) | Code   | Pack Qty | Price (each) |
|---|-----------|--------|----------|--------------|
| <b>End Cap (No seals or couplings supplied)</b> | 100       | EC1059 | 10       | 2.23         |
|   | 150       | EC1778 | 10       | 5.37         |
|   | 225       | EC5064 | 10       | 21.07        |
|   | 300       | EC6010 | 10       | 37.32        |

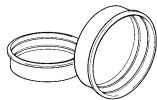

Not suitable for air tests.

PLEASE ALLOW 3 DAYS FOR DELIVERY

PLEASE ALLOW 7 DAYS FOR DELIVERY

MADE TO ORDER ONLY

**GULLIES & ACCESSORIES**

| Midi-Gully HDPE Yard Gully & Accessories     |          |          |              |
|--|----------|----------|--------------|
| Description                                  | Code     | Pack Qty | Price (each) |
| 300mm Diameter x 600mm Depth HDPE Yard Gully | RG300600 | 36       | 40.84        |
| Silt Bucket                                  | RGSB     | 1        | 47.63        |
| Grating (Class B125 to BS EN124)             | RGG      | 1        | 134.41       |

| Ridgigully HDPE Road Gullies & Adaptors      |          |          |              |
|--|----------|----------|--------------|
| Description                                  | Code     | Pack Qty | Price (each) |
| 450mm Diameter x 750mm Depth HDPE Road Gully | RG450750 | 16       | 44.23        |
| 450mm Diameter x 900mm Depth HDPE Road Gully | RG450900 | 16       | 45.94        |
| Multi-Adaptor                                | ARGMulti | 20       | 8.52         |

| Ridgiflex 150mm Diameter HDPE Gully Connection Pipe |         |          |              |
|---|---------|----------|--------------|
| Description   | OD (mm) | Code     | Price (each) |
| 25 metre coil                                       | 178     | RF150X25 | 129.75       |



**ADAPTORS**

| Level Invert Reducers   |       |       |           |              |
|---|-------|-------|-----------|--------------|
| Description   | A(mm) | B(mm) | Code      | Price (each) |
| Level Invert Reducers<br><br>Other Level Invert Reducers<br>are available on request. | 150   | 100   | ARD150100 | 24.26        |
|   | 225   | 150   | ARD225150 | 35.54        |
|   | 300   | 150   | ARD300150 | 57.29        |
|   | 300   | 225   | ARD300225 | 67.20        |
|   | 375   | 225   | ARD375225 | 102.12       |
|   | 375   | 300   | ARD375300 | 133.61       |
|   | 500   | 450   | ARD500450 | P.O.A        |
|   | 600   | 500   | ARD600500 | P.O.A        |

| Polypipe Ridgidrain to BS4660 Spigot         |           |          |              |
|--|-----------|----------|--------------|
| Description                                  | Code      | Pack Qty | Price (each) |
| 100mm socket to 110mm EN1401 (BS4660) spigot | ARD100110 | 10       | 16.78        |
| 150mm socket to 160mm EN1401 (BS4660) spigot | ARD150160 | 10       | 22.88        |

| Polypipe Ridgidrain to BS4660 Socket         |                   |          |              |
|--|-------------------|----------|--------------|
| Description                                  | Code              | Pack Qty | Price (each) |
| 100mm socket to 110mm EN1401 (BS4660) socket | ARD100110 & UG401 | 10       | 16.78+4.84   |
| 150mm socket to 160mm EN1401 (BS4660) socket | ARD150160 & UG601 | 10       | 22.88+9.54   |

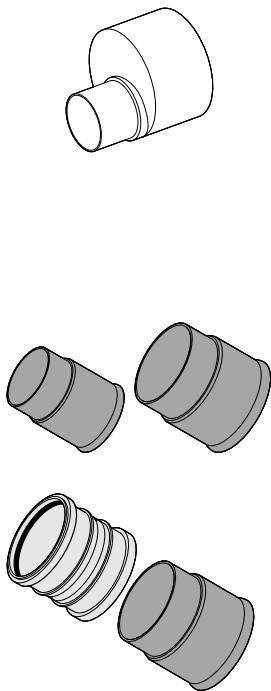

PLEASE ALLOW 3 DAYS FOR DELIVERY

PLEASE ALLOW 7 DAYS FOR DELIVERY

MADE TO ORDER ONLY

**ADAPTORS**

| Polypipe Ridgidrain to Super Clay Socket |                   |          |              |
|--|-------------------|----------|--------------|
| Description                              | Code              | Pack Qty | Price (each) |
| 100mm socket to 100mm super clay socket  | ARD100110 & UG434 | 10       | 16.78+9.02   |
| 150mm socket to 150mm super clay socket  | ARD150160 & UG634 | 10       | 22.88+13.57  |

| Polypipe Ridgidrain to Thick Clay Socket |                     |          |              |
|--|---------------------|----------|--------------|
| Description                              | Code                | Pack Qty | Price (each) |
| 100mm socket to 100mm thick clay socket  | ARD100110 and UG486 | 10       | 16.78+9.59   |
| 150mm socket to 150mm thick clay socket  | ARD150160 and UG696 | 10       | 22.88+14.24  |

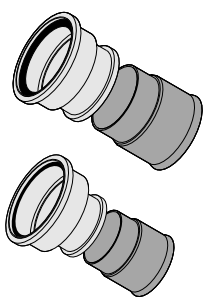

Order seals separately if required

**SPECIALIST FABRICATIONS**

Following the outstanding track record of conventional Ridgidrain pipe and fittings. Polypipe Civils have made a substantial capital investment in a state of the art fabrications facility.

Fabrications are manufactured in sizes up to 2 metres in diameter and include:

- Catchpits
- Manholes
- Soakaways
- Ducting drawpits
- Pump sampling and inspection chambers

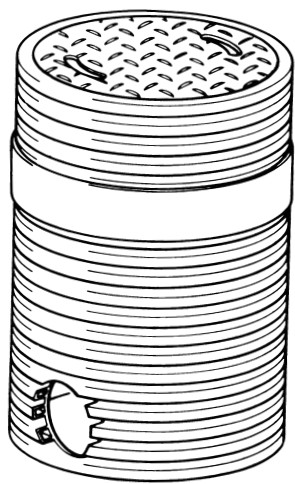

Fabrications can be made to precise customer specifications with standard products also available for road and rail applications.



**Benefits:**

- Fabricated to exact customer specifications
- Excellent impact and abrasion resistance properties
- Minimal storage space required
- Lightweight
- Versatility and adaptability
- Single piece or segmented constructions available
- Optional Step Irons to BS1247

All the fittings are fully compatible with Polypipe Civils Ridgidrain system.

PLEASE ALLOW 3 DAYS FOR DELIVERY

PLEASE ALLOW 7 DAYS FOR DELIVERY

MADE TO ORDER ONLY

**POLYSTORM SYSTEM**

**Polystorm System**

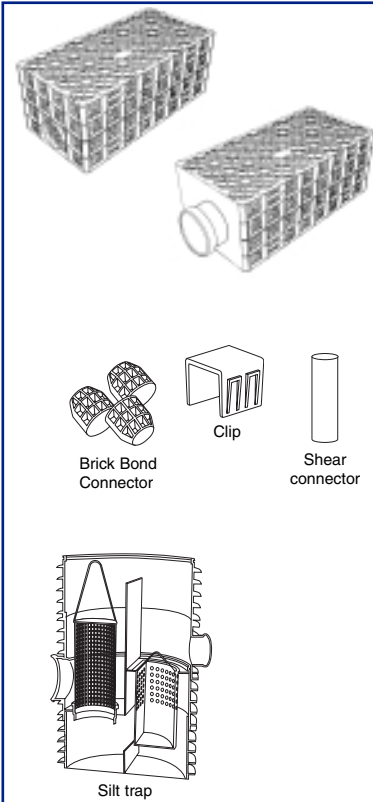

| Description                          | Code         | Pack Qty | Price (each) |
|--------------------------------------|--------------|----------|--------------|
| Polystorm Cell 1000x500x400mm        | PSM1         | 15       | 58.99        |
| Polystorm Cell with 225mm connector  | PSMCRD225    | 1        | 107.04       |
| Polystorm Cell with 300mm connector  | PSMCRD300    | 1        | 107.04       |
| Brick bond shear connector           | PSMBBSC      | 30       | 0.83         |
| Clips                                | PSMCLIP      | 60       | 0.83         |
| Shear connector                      | PSMSC        | 30       | 0.83         |
| EN1401 Flange Adaptor - 110mm        | PSMFA110     | 1        | 25.34        |
| Ridgidrain Flange Adaptor - 150mm    | PSMFA150     | 1        | 25.34        |
| EN1401 Flange Adaptor - 160mm        | PSMFA160     | 1        | 25.34        |
| Basic silt trap                      | PSMST160     | 1        | 281.52       |
| Advanced silt trap - 15 litres / sec | PSMSTA160/15 | 1        | 492.68       |
| 450mm silt trap lid & frame          | UG512        | 1        | 65.54        |
| 460mm lockable plastic cover & frame | UG511        | 1        | 45.93        |
| Polypropylene cover & frame          | ICDC1        | 1        | 65.54        |
| Chamber riser section                | ICDR1        | 1        | 28.69        |
| Silt trap sealing ring               | UG488        | 1        | 2.61         |

PLEASE ALLOW 3 DAYS FOR DELIVERY

PLEASE ALLOW 7 DAYS FOR DELIVERY

MADE TO ORDER ONLY

**STORMCHECK CHAMBER**

The Stormcheck "Vortex Flow Control Chamber" is the latest addition to the Sustainable Drainage (SUDS) suite of products from Polypipe Civils.

The new Stormcheck chamber allows precise control of site discharge rates.

**Features:**

- Pre-Fabricated to customer specification.
- Choice of Depth up to a maximum invert level of six meters.
- Lightweight, yet tough and durable product.
- Designed to be used in conjunction with Polypipe Stormwater Solutions.
- Choice of chamber sizes from: 1050mmØ, 1200mmØ, 1500mmØ and 1800mmØ.
- Option of Step Irons to BS1247

Polypipe Civils manufactures a range of chambers, available with or without bypass systems.

**Benefits of the Stormcheck Chamber**

- Produced in our dedicated fabrications department.
- Built to exacting customer specifications and delivered to site ready to be installed.
- The factory fitted Vortex Control Device saves the contractor time.
- Vortex Control Devices are widely recognised as being the most hydraulically efficient means of flow regulation.
- Integral sump for silt catchment
- Optional drain down system to ease maintenance and silt removal.
- The Stormcheck Chamber can be integrated with any Polypipe SUDs Solution and the market leading Ridgidrain ADS System.



**RIDGIDRAIN FIN AND NARROW FILTER DRAINS**

**Type 6 Fin Drain**

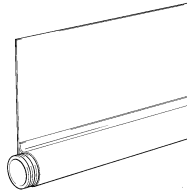

| Description             | Depth (mm) | Code           | Price |
|-------------------------|------------|----------------|-------|
| <b>Type 6 Fin Drain</b> | 600        | FD80X12.5X600  | 8.34  |
|                         | 750        | FD80X12.5X750  | 10.36 |
|                         | 600        | FD100X12.5X600 | 10.23 |
|                         | 750        | FD100X12.5X750 | 11.23 |
|                         | 600        | FD160X12.5X600 | 11.83 |
|                         | 750        | FD160X12.5X750 | 13.84 |

Single wall corrugated pipe to BS 4962:1989 supplied assembled with plastic fin wrapped in geotextile. Available in 80, 100 and 160mm diameters. Insert required diameter in place of 'S' in product code.

These items are made to order and subject to lead times. Minimum order 10 packs per size

**Type 8 Filter Drain**

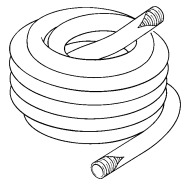

| Description                | Diameter (mm) | Length (m) | Code     | Price (each) |
|----------------------------|---------------|------------|----------|--------------|
| <b>Type 8 Filter Drain</b> | 60            | 150        | GE60150  | 236.77       |
|                            | 80*           | 100        | GE80100  | 228.35       |
|                            | 100*          | 100        | GE100100 | 319.04       |
|                            | 125           | 75         | GE12575  | 337.50       |
|                            | 160           | 45         | GE16045  | 308.98       |

Pipe supplied wrapped in geotextile. These items are made to order and subject to lead times and minimum order quantities.

\* These items are available from stock.

**LUBRICANT**

**Lubricant**



| Description                     | Size          | Code          | Pack Qty      | Price (each)  |
|---------------------------------|---------------|---------------|---------------|---------------|
| <b>Plastic Tub of Lubricant</b> | 1kg           | LUBX1         | 12            | 8.64          |
|                                 | 2.5kg         | LUBX2.5       | 4             | 21.54         |
| <b>Minimum Usage Chart</b>      | Diameter (mm) | kg per pallet | Diameter (mm) | Joints per kg |
|                                 | 100           | 0.5           | 400           | 64            |
|                                 | 150           | 0.4           | 450           | 56            |
|                                 | 225           | 0.3           | 500           | 48            |
|                                 | 300           | 0.2           | 600           | 40            |
|                                 | 375           | 0.15          | 750           | 25            |
|                                 |               |               | 900           | 20            |
|                                 |               |               | 1050          | 15            |

**RIDGISEWER**

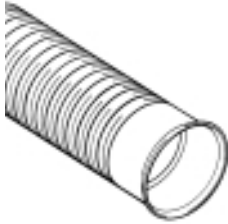

| Pipe   |           |        |        |             |               |                  |                 |
|--|-----------|--------|--------|-------------|---------------|------------------|-----------------|
| Description  | Nom. Size | ID(mm) | OD(mm) | Code        | Pack quantity | Price per length | Price per metre |
| <b>Integrally Socketed</b><br><b>Stiffness Class 4</b><br><b>6 metre lengths</b> | 400       | 400    | 457    | RSW400X6IS4 | 5             | 423.78           | 70.63           |
|  | 450       | 450    | 511    | RSW450X6IS4 | 1             | 464.88           | 77.48           |
|  | 500       | 500    | 568    | RSW500X6IS4 | 1             | 547.64           | 84.13           |
|  | 600       | 587    | 672    | RSW600X6IS4 | 1             | 717.01           | 119.50          |
| <b>3 metre lengths</b>   | 400       | 400    | 457    | RSW400X3IS4 | 5             | 211.89           | 70.63           |
|  | 450       | 450    | 511    | RSW450X3IS4 | 1             | 232.45           | 77.48           |
|  | 500       | 500    | 568    | RSW500X3IS4 | 1             | 273.83           | 91.28           |
|  | 600       | 587    | 672    | RSW600X3IS4 | 1             | 358.49           | 119.50          |
|  | 750       | 765    | 880    | RSW750X3IS4 | 1             | 496.05           | 165.35          |
|  | 900       | 909    | 1032   | RSW900X3IS4 | 1             | 830.63           | 276.88          |



**WIS 4-35-01**  
**KM55701**  
Covers pipe, seals and couplings

**Order seals and couplings separately as required.**

**Stiffness Class 8 and Plain ended Ridgisewer is available as a special made to order item and is subject to minimum order quantities and lead times.**

**RIDGISEWER**

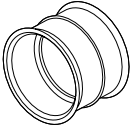

| Double Socket Couplings   |                |         |          |              |  |
|---|----------------|---------|----------|--------------|--|
| Description   | Nom. Size (mm) | Code    | Pack Qty | Price (each) |  |
| <b>Double Socket Couplings</b><br>Order seals separately if required. | 400            | RSWC400 | 1        | 43.36        |  |
|   | 450            | RSWC450 | 1        | 49.30        |  |
|   | 500            | RSWC500 | 1        | 76.48        |  |
|   | 600            | RSWC600 | 1        | 106.13       |  |



**WIS 4-35-01**  
**KM55701**

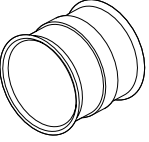



| Double Socket Slip Couplings   |                |          |          |              |  |
|--|----------------|----------|----------|--------------|--|
| Description  | Nom. Size (mm) | Code     | Pack Qty | Price (each) |  |
| <b>Double Socket Slip Couplings</b><br>Order seals separately if required. | 400            | RSWSC400 | 1        | 45.52        |  |
|  | 450            | RSWSC450 | 1        | 51.74        |  |
|  | 500            | RSWSC500 | 1        | 80.30        |  |
|  | 600            | RSWSC600 | 1        | 110.92       |  |





**RIDGISEWER**

**Sealing Rings**

| Description  | Nom. Size (mm) | Code   | Pack Qty | Price (each) |
|--|----------------|--------|----------|--------------|
|  <p><b>Sealing Rings</b><br/>Ridgidrain and Ridgisewer seals are now identical and offered at the same list price.</p>  <p>WIS 4-35-01<br/>KM55701</p> | 400            | SRD400 | 2        | 16.58        |
|  | 450            | SRD450 | 2        | 18.34        |
|  | 500            | SRD500 | 2        | 31.04        |
|  | 600            | SRD600 | 2        | 45.72        |
|  | 750            | SRD750 | 1        | 66.67        |
|  | 900            | SRD900 | 1        | 88.91        |

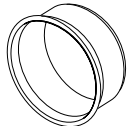
**End Caps**

| Description   | Nom. Size (mm) | Code     | Pack Qty | Price (each) |
|---|----------------|----------|----------|--------------|
|  <p><b>End Caps</b><br/>Order seals separately if required.</p>  <p><b>BBA</b> BRITISH BOARD OF AGREEMENT<br/>CERTIFICATE No. 03/9779</p> | 400            | RSWEC400 | 1        | 43.36        |
|   | 450            | RSWEC450 | 1        | 49.30        |
|   | 500            | RSWEC500 | 1        | 76.48        |
|   | 600            | RSWEC600 | 1        | 106.13       |
|   | 750            | RSWEC750 | 1        | 240.36       |
|   | 900            | RSWEC900 | 1        | 300.03       |

**Bends**

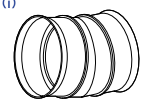
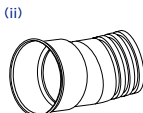
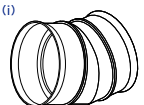
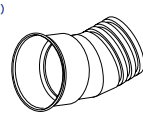
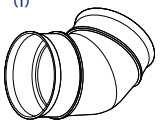
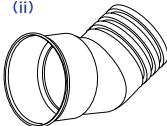
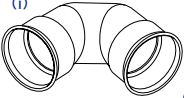
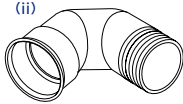
| Description  | Nom. Size (mm) | Code         | Pack Qty | Price (each) |
|--|----------------|--------------|----------|--------------|
|   <p><b>11.25° Short Radius Bends</b><br/>Order seals separately if required.<br/>These bends are made to order and subject to lead times.</p> | 400            | RSWB40011.25 | 1        | 294.29       |
|  | 450            | RSWB45011.25 | 1        | 307.62       |
|  | 500            | RSWB50011.25 | 1        | 424.53       |
|  | 600            | RSWB60011.25 | 1        | 490.39       |
|  | 750            | RSWB75011.25 | 1        | 1217.66      |
|  | 900            | RSWB90011.25 | 1        | 1409.69      |
|   <p><b>22.5° Short Radius Bends</b><br/>Order seals separately if required.<br/>These bends are made to order and subject to lead times.</p>  | 400            | RSWB40022.5  | 1        | 294.29       |
|  | 450            | RSWB45022.5  | 1        | 307.62       |
|  | 500            | RSWB50022.5  | 1        | 424.53       |
|  | 600            | RSWB60022.5  | 1        | 490.39       |
|  | 750            | RSWB75022.5  | 1        | 1217.66      |
|  | 900            | RSWB90022.5  | 1        | 1409.69      |
|   <p><b>45° Short Radius Bends</b><br/>Order seals separately if required.<br/>These bends are made to order and subject to lead times.</p>    | 400            | RSWB40045    | 1        | 294.29       |
|  | 450            | RSWB45045    | 1        | 307.62       |
|  | 500            | RSWB50045    | 1        | 424.53       |
|  | 600            | RSWB60045    | 1        | 490.39       |
|  | 750            | RSWB75045    | 1        | 1217.66      |
|  | 900            | RSWB90045    | 1        | 1409.69      |
|   <p><b>90° Short Radius Bends</b><br/>Order seals separately if required.<br/>These bends are made to order and subject to lead times.</p>    | 400            | RSWB40090    | 1        | 294.29       |
|  | 450            | RSWB45090    | 1        | 307.62       |
|  | 500            | RSWB50090    | 1        | 424.53       |
|  | 600            | RSWB60090    | 1        | 490.39       |
|  | 750            | RSWB75090    | 1        | 1338.54      |
|  | 900            | RSWB90090    | 1        | 1554.82      |

PLEASE ALLOW 3 DAYS FOR DELIVERY



PLEASE ALLOW 7 DAYS FOR DELIVERY

MADE TO ORDER ONLY

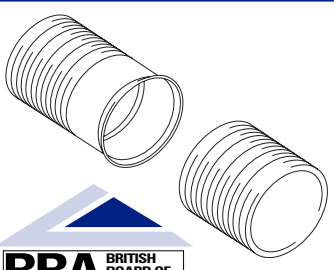
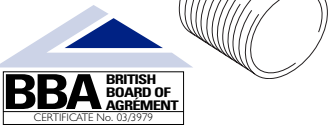
**RIDGISEWER**

| <b>Bends</b>  |                |          |          |              |
|---|----------------|----------|----------|--------------|
| Description   | Nom. Size (mm) | Code     | Pack Qty | Price (each) |
| <br><b>Rocker pipes</b><br>Order seals separately if required. | 750            | RSWRP750 | 1        | P.O.A.       |
|   | 900            | RSWRP900 | 1        | P.O.A.       |
| <br><b>Stub pipes</b><br>Order seals separately if required.   | 750            | RSWST750 | 1        | P.O.A.       |
|   | 900            | RSWST900 | 1        | P.O.A.       |

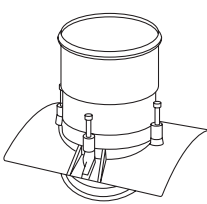
**RIDGITITE**

| <b>Ridgitite</b>   |                 |           |          |              |
|--|-----------------|-----------|----------|--------------|
| Description  | Description     | Code      | Pack Qty | Price (each) |
| <br><b>Connecting Saddles to suit Ridgidrain &amp; Ridgisewer except as noted</b><br> | 300mm           | SLD300    | 1        | 130.92       |
|  | 375/400/450mm   | SLD375450 | 1        | 136.81       |
|  | 500mm           | SLD500    | 1        | 161.21       |
|  | 600mm           | SLD600    | 1        | 173.28       |
|  | 300mm Polysewer | SLDPS300  | 1        | 130.92       |
|  | 177mm Hole Saw  | HOL177    | 1        | P.O.A.       |

**RIDGISEWER**

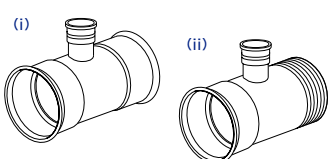
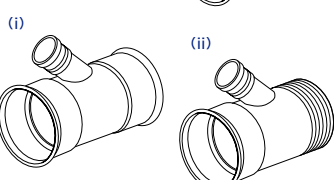
| <b>Junctions</b>   |                |               |          |              |
|--|----------------|---------------|----------|--------------|
| Description  | Nom. Size (mm) | Code          | Pack Qty | Price (each) |
| <br><b>90° Unequal Junctions</b><br>Order seals separately if required.<br>ii. These junctions are made to order and subject to lead times. | 400x160        | RSWJ400160T   | 1        | 229.17       |
|  | 450x160        | RSWJ450160T   | 1        | 245.82       |
|  | 500x160        | RSWJ500160T   | 1        | 327.80       |
|  | 600x160        | RSWJ600160T   | 1        | 351.96       |
|  | 750x160        | RSWJ750160T   | 1        | 883.38       |
|  | 900x160        | RSWJ900160T   | 1        | 965.23       |
| <br>110 & 160mm branches are for EN1401 pipes.<br><br>150mm branches are for Polysewer.   | 400x150        | RSWPSJ400150T | 1        | 229.17       |
|  | 450x150        | RSWPSJ450150T | 1        | 245.82       |
|  | 500x150        | RSWPSJ500150T | 1        | 327.80       |
|  | 600x150        | RSWPSJ600150T | 1        | 351.96       |
|  | 750x150        | RSWPSJ750150T | 1        | 883.38       |
|  | 900x150        | RSWPSJ900150T | 1        | 934.47       |

PLEASE ALLOW 3 DAYS FOR DELIVERY      PLEASE ALLOW 7 DAYS FOR DELIVERY      MADE TO ORDER ONLY

**RIDGISEWER**

**Junctions**

| Description | Nom. Size (mm) | Code | Pack Qty | Price (each) |
|-------------|----------------|------|----------|--------------|
|-------------|----------------|------|----------|--------------|

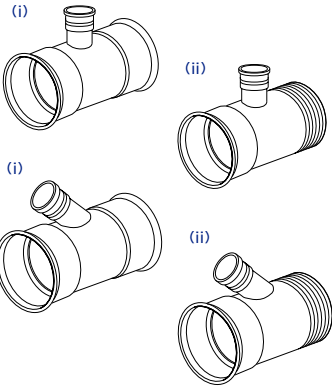

**45° Unequal Junctions**  
 Order seals separately if required.  
 110 & 160mm branches are for EN1401 pipes.  
 150mm branches are for Polysewer.

ii. These junctions are made to order and subject to lead times.

|    |         |               |   |        |
|----|---------|---------------|---|--------|
| i  | 400x110 | RSWJ400110Y   | 1 | 221.88 |
|    | 400x160 | RSWJ400160Y   | 1 | 229.17 |
|    | 450x110 | RSWJ450110Y   | 1 | 243.36 |
|    | 450x160 | RSWJ450160Y   | 1 | 245.82 |
| ii | 500x160 | RSWJ500160Y   | 1 | 327.80 |
|    | 600x160 | RSWJ600160Y   | 1 | 351.96 |
|    | 750x160 | RSWJ750160Y   | 1 | 914.18 |
|    | 900x160 | RSWJ900160Y   | 1 | 965.23 |
| i  | 400x150 | RSWPSJ400150Y | 1 | 229.17 |
|    | 450x150 | RSWPSJ450150Y | 1 | 245.82 |
|    | 500x150 | RSWPSJ500150Y | 1 | 327.80 |
|    | 600x150 | RSWPSJ600150Y | 1 | 351.96 |
| ii | 750x150 | RSWPSJ750150Y | 1 | 914.18 |
|    | 900x150 | RSWPSJ900150Y | 1 | 965.23 |

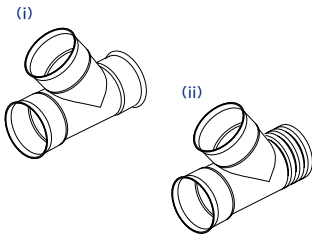

**45° Equal Junctions**  
 Order seals separately if required.

(ii) These junctions are made to order and subject to lead times.

|    |     |           |   |         |
|----|-----|-----------|---|---------|
| i  | 400 | RSWEJ400Y | 1 | 603.56  |
|    | 450 | RSWEJ450Y | 1 | 780.60  |
|    | 500 | RSWEJ500Y | 1 | 1092.86 |
|    | 600 | RSWEJ600Y | 1 | 1189.28 |
| ii | 750 | RSWEJ750Y | 1 | 2985.02 |
|    | 900 | RSWEJ900Y | 1 | 3223.43 |

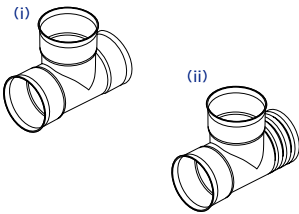

**90° Equal Junctions**  
 Order seals separately if required.

(ii) These junctions are made to order and subject to lead times.

|    |     |           |   |         |
|----|-----|-----------|---|---------|
| i  | 400 | RSWEJ400T | 1 | 603.56  |
|    | 450 | RSWEJ450T | 1 | 780.60  |
|    | 500 | RSWEJ500T | 1 | 1092.86 |
|    | 600 | RSWEJ600T | 1 | 1189.28 |
| ii | 750 | RSWEJ750T | 1 | 2755.10 |
|    | 900 | RSWEJ900T | 1 | 2998.03 |



**3m 45° Junctions**

| Description | Nom. Size (mm) | Branch Size (mm) | Code | Pack Qty | Price |
|-------------|----------------|------------------|------|----------|-------|
|-------------|----------------|------------------|------|----------|-------|

|  |     |     |                  |   |        |
|--|-----|-----|------------------|---|--------|
| <b>Single Branch</b><br><br>These are specialist fabrications, manufactured to order and subject to extended lead times<br><br>Double branch junctions available Made to Order | 400 | 150 | RSWPSJ400150YX3S | 1 | P.O.A. |
|  | 400 | 160 | RSWJ400160YX3S   | 1 | P.O.A. |
|  | 450 | 150 | RSWPSJ450150YX3S | 1 | P.O.A. |
|  | 450 | 160 | RSWJ450160YX3S   | 1 | P.O.A. |
|  | 500 | 150 | RSWPSJ500150YX3S | 1 | P.O.A. |
|  | 500 | 160 | RSWJ500160YX3S   | 1 | P.O.A. |
|  | 600 | 150 | RSWPSJ600150YX3S | 1 | P.O.A. |
|  | 600 | 160 | RSWJ600160YX3S   | 1 | P.O.A. |
|  | 750 | 150 | RSWPSJ750150YX3S | 1 | P.O.A. |
|  | 750 | 160 | RSWJ750160YX3S   | 1 | P.O.A. |
|  | 900 | 150 | RSWPSJ900150YX3S | 1 | P.O.A. |
|  | 900 | 160 | RSWJ900160YX3S   | 1 | P.O.A. |

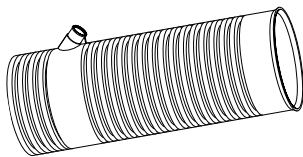

**POLYSEWER**

**Integrally Socketed Pipe Class 8**

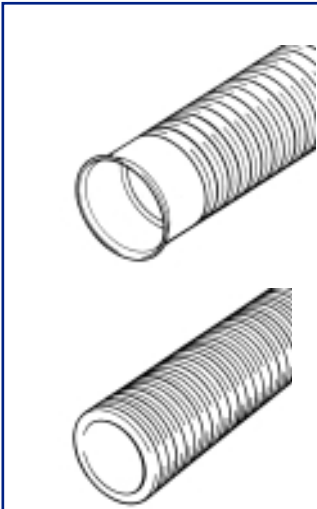

| Description                     | Nom. Size | ID(mm) | OD(mm) | Code   | Length | Pack Qty | Price per length | Price per metre |
|---------------------------------|-----------|--------|--------|--------|--------|----------|------------------|-----------------|
| <b>Integrally Socketed pipe</b> | 150       | 146    | 160    | PS632  | 3      | 46       | 19.83            | 6.61            |
|                                 | 225       | 229    | 160    | PS1032 | 3      | 23       | 46.65            | 15.55           |
|                                 | 300       | 301    | 330    | PS1232 | 3      | 9        | 71.31            | 23.77           |
|                                 | 150       | 146    | 160    | PS662  | 6      | 46       | 39.65            | 6.61            |
|                                 | 225       | 229    | 250    | PS1062 | 6      | 23       | 91.73            | 15.29           |
|                                 | 300       | 301    | 330    | PS1262 | 6      | 9        | 141.08           | 23.51           |
| <b>Plain Ended pipe</b>         | 150       | 146    | 160    | PS630  | 3      | 46       | 17.27            | 5.76            |
|                                 | 225       | 229    | 250    | PS1030 | 3      | 23       | 43.12            | 14.37           |
|                                 | 300       | 301    | 330    | PS1230 | 3      | 9        | 62.54            | 20.85           |
|                                 | 150       | 146    | 160    | PS660  | 6      | 46       | 34.55            | 5.76            |
|                                 | 225       | 229    | 250    | PS1060 | 6      | 23       | 86.27            | 14.38           |
|                                 | 300       | 301    | 330    | PS1260 | 6      | 9        | 129.94           | 21.66           |

**Double Socket Coupling**

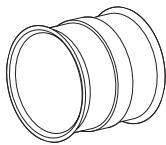

| Description   | Nom. Size (mm) | Code   | Pack Qty | Price (each) |
|---|----------------|--------|----------|--------------|
| <b>Double Socket coupling (Supplied with 2 seals)</b> | 150            | PS601  | 10       | 7.86         |
|   | 225            | PS1001 | 1        | 19.18        |
|   | 300            | PS1201 | 1        | 37.26        |

**Bends**

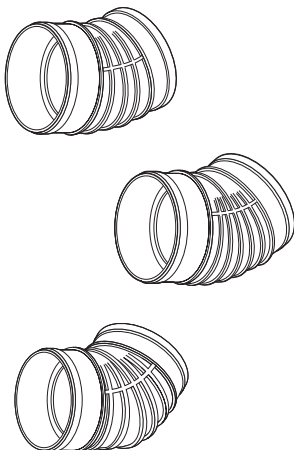

| Description                                    | Nom. Size (mm) | Code   | Pack Qty | Price (each) |
|--|----------------|--------|----------|--------------|
| <b>15 degree bends (supplied with 2 seals)</b> | 150            | PS609  | 10       | 13.50        |
|  | 225            | PS1009 | 1        | 51.62        |
|  | 300            | PS1209 | 1        | 84.21        |
| <b>30 degree bends (supplied with 2 seals)</b> | 150            | PS667  | 10       | 13.50        |
|  | 225            | PS1067 | 1        | 53.16        |
|  | 300            | PS1267 | 1        | 88.60        |
| <b>45 degree bends (supplied with 2 seals)</b> | 150            | PS603  | 10       | 13.50        |
|  | 225            | PS1003 | 1        | 54.51        |
|  | 300            | PS1203 | 1        | 91.27        |
| <b>90 degree bends (supplied with 2 seals)</b> | 150            | PS611  | 5        | 15.79        |
|  | 225            | PS1011 | 1        | 67.21        |
|  | 300            | PS1211 | 1        | 106.40       |

PLEASE ALLOW 3 DAYS FOR DELIVERY

PLEASE ALLOW 7 DAYS FOR DELIVERY

MADE TO ORDER ONLY

**POLYSEWER**

**End Caps**

| Description                          | Nom. Size (mm) | Code    | Pack Qty | Price (each) |
|--------------------------------------|----------------|---------|----------|--------------|
| End Caps (each supplied with 1 seal) | 150            | PS6101  | 10       | 5.76         |
|                                      | 225            | PS10101 | 1        | 19.86        |
|                                      | 300            | PS12101 | 1        | 29.81        |

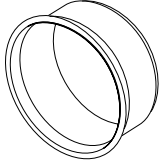

**Junctions**

| Description           | Nom. Size (mm) | Code     | Pack Qty | Price (each) |
|-----------------------|----------------|----------|----------|--------------|
| 45° Equal junctions   | 150            | PS605    | 5        | 27.47        |
|                       | 225            | PS1005   | 1        | 99.94        |
|                       | 300            | PS1205   | 1        | 213.85       |
| 90° Equal junctions   | 150            | PS623    | 5        | 27.47        |
| 45° Unequal Junctions | 150x110        | PS635RS  | 5        | 24.13        |
|                       | 225x110        | PS1035RS | 1        | 77.80        |
|                       | 225x150        | PS1031   | 1        | 65.06        |
|                       | 225x160        | PS1031RS | 1        | 70.34        |
|                       | 300x110        | PS1235RS | 1        | 123.48       |
|                       | 300x150        | PS1231   | 1        | 105.82       |
|                       | 300x160        | PS1231RS | 1        | 111.12       |
|                       | 300x225        | PS12100  | 1        | 203.56       |
| 90° Unequal junctions | 150x110        | PS643RS  | 5        | 24.13        |

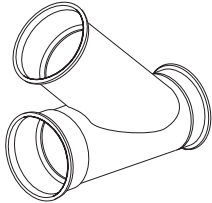

Other Adaptors ie: for clay pipes are available on request

**Socket Adaptors**

| Description   | Nom. Size (mm) | Code   | Pack Qty | Price (each) |
|---|----------------|--------|----------|--------------|
| Socket Adaptors to EN1401-1<br>(Each supplied with 2 seals) | 150            | PS689  | 10       | 24.40        |
|   | 225            | PS1089 | 1        | 67.18        |
|   | 300            | PS1289 | 1        | 83.24        |

**Level Invert Reducers**

| Description                                    | A(mm) | B(mm) | Code   | Pack Qty | Price (each) |
|--|-------|-------|--------|----------|--------------|
| Level Invert Reducers<br>(Supplied with seals) | 225   | 150   | PS1021 | 1        | 45.04        |
|  | 300   | 220   | PS1221 | 1        | 82.22        |

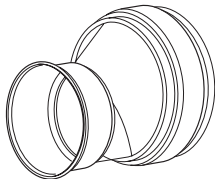

**Sealing Rings and Rodding Eye**

| Description   | Nom. Size (mm) | Code   | Pack Qty | Price (each) |
|---------------|----------------|--------|----------|--------------|
| Sealing Rings | 150            | PSSP1  | 10       | 0.93         |
|               | 225            | PSSP2  | 10       | 1.90         |
|               | 300            | PSSP3  | 10       | 4.13         |
| Rodding Eye   | 150            | PS6225 | 8        | 61.36        |

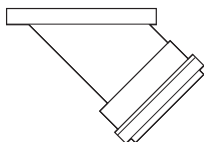

PLEASE ALLOW 3 DAYS FOR DELIVERY

PLEASE ALLOW 7 DAYS FOR DELIVERY

MADE TO ORDER ONLY

**DUCTING SYSTEMS**

**Typical Colour Coding and Important Notes**

**Description**

- |  |                                       |
|--|---------------------------------------|
| <b>Black (B) - Electricity</b>                 | <b>Yellow (Y) - Gas</b>               |
| <b>Orange (O) - Street Lighting</b>            | <b>Blue (BL) - Water</b>              |
| <b>Purple (P) - Motorway Communications</b>    | <b>Green (G) - Cable Television</b>   |
| <b>Purple (P) - Street Lighting (Scotland)</b> | <b>Grey (GR) - Telecommunications</b> |

Colours and printing may vary from region to region, please check with appropriate authority.

Special colours and prints may be subject to lead times and minimum order quantities. Slow moving products may also be subject to minimum order quantities and lead times. Availability must be checked with Polypipe Civils prior to order placement.

If a specific grade of colour is required this should be stated at time of enquiry and order placement. Supply may be subject to lead times and minimum order quantities. The colour of standard black uPVC ducting products ranges from grey to black.

**RIDGIDUCT - TWIN WALL DUCT**

**Ridgiduct - Black Twin Wall Electric Cable Duct**

| Description                 | ID (mm)                | OD (mm) | Code    | Pack Qty | Price per length | Price per metre |
|-----------------------------|------------------------|---------|---------|----------|------------------|-----------------|
| <b>2 metre lengths</b>      | 100                    | 118     | RB100X2 | 85       | 9.67             | 4.83            |
| Printed Electric Cable Duct | 125                    | 148     | RB125X2 | 46       | 13.60            | 6.80            |
|                             | 150                    | 178     | RB150X2 | 36       | 14.22            | 7.11            |
|                             | <b>3 metre lengths</b> | 100     | 118     | RB100X3  | 85               | 13.53           |
| Printed Electric Cable Duct | 125                    | 148     | RB125X3 | 46       | 19.41            | 6.47            |
|                             | 150                    | 178     | RB150X3 | 36       | 20.36            | 6.79            |
|                             | <b>6 metre lengths</b> | 94      | 110     | RB94X6   | 95               | 15.72           |
| Printed Electric Cable Duct | 100                    | 118     | RB100X6 | 85       | 22.74            | 3.79            |
|                             | 125                    | 148     | RB125X6 | 46       | 31.85            | 5.31            |
|                             | 150                    | 178     | RB150X6 | 36       | 33.30            | 5.55            |

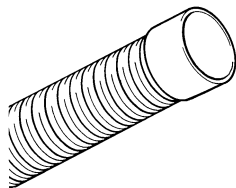

A range of coloured ducts are available made to order, subject to minimum order quantities and lead times.

High Density Polyethylene twin wall ducting (Not including 94mm ducts) for underground cables, is manufactured to ESI 12/24 and BS EN50086-2-4.

Supplied with one coupling fitted per length.

PLEASE ALLOW 3 DAYS FOR DELIVERY

PLEASE ALLOW 7 DAYS FOR DELIVERY

MADE TO ORDER ONLY

**RIDGIDUCT - TWIN WALL DUCT**

**Ridgiduct - Twin Wall Electric Cable Duct**

| Description | Diameter (mm) | Code | Pack Qty | Price per length | Price per metre |
|-------------|---------------|------|----------|------------------|-----------------|
|-------------|---------------|------|----------|------------------|-----------------|

**Ridgiduct Black Twin Wall Split Duct**

|                 |     |          |    |       |       |
|-----------------|-----|----------|----|-------|-------|
| 1 metre lengths | 100 | RB100X1S | 85 | 7.16  | 7.16  |
|                 | 125 | RB125X1S | 46 | 9.85  | 9.85  |
|                 | 150 | RB150X1S | 36 | 12.65 | 12.65 |
| 2 metre lengths | 100 | RB100X2S | 85 | 13.17 | 6.58  |
|                 | 125 | RB125X2S | 46 | 19.36 | 9.68  |
|                 | 150 | RB150X2S | 36 | 24.94 | 12.47 |
| 3 metre lengths | 100 | RB100X3S | 85 | 18.87 | 6.29  |
|                 | 125 | RB125X3S | 46 | 27.78 | 9.26  |
|                 | 150 | RB150X3S | 36 | 36.65 | 12.22 |

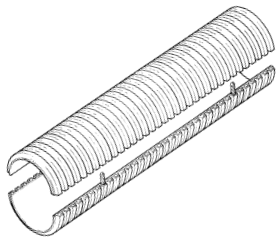

Registered Design

**Ridgiduct - Motorway Communications Sealed Duct**

| Description | Nom. Size | Length (m) | Code | Pack Quantity | Price per length | Price per metre |
|-------------|-----------|------------|------|---------------|------------------|-----------------|
|-------------|-----------|------------|------|---------------|------------------|-----------------|

|                                |      |    |                |    |       |      |
|--------------------------------|------|----|----------------|----|-------|------|
| <b>Purple sealed duct</b>      | 94   | 6  | RB94X6PMCPPE   | 95 | 23.94 | 3.99 |
| Printed Motorway Comms / Power | 94*  | 12 | RB94X12PMCPPE  | 60 | 47.88 | 3.99 |
|                                | 100  | 6  | RB100X6PMCPPE  | 85 | 24.82 | 4.14 |
|                                | 100* | 12 | RB100X12PMCPPE | 60 | 49.67 | 4.14 |
| <b>Black sealed duct</b>       | 94*  | 6  | RB94X6BMCPE    | 95 | 20.54 | 3.42 |
| Printed Motorway Comms / Power | 94*  | 12 | RB94X12BMCPE   | 60 | 41.12 | 3.43 |
|                                | 100* | 6  | RB100X6BMCPE   | 85 | 22.48 | 3.75 |
|                                | 100* | 12 | RB100X12BMCPE  | 60 | 44.98 | 3.75 |



Order seals and couplings separately

|  |        |     |  |  | Price |
|--|--------|-----|--|--|-------|
| <b>Black Coupling</b>                          | CRD94  | 50  |  |  | 2.92  |
|  | CRD100 | 43  |  |  | 3.30  |
| <b>Sealing Rings, EPDM to BS EN681: Part 1</b> | SRD94  | 190 |  |  | 0.90  |
|  | SRD100 | 170 |  |  | 0.95  |

Nitrile seals are available subject to lead time and order quantity. Add 15% and state at time of order.

Conforms to Highways Agency Specifications for Sealed Systems.

\* Made to order and are subject to minimum order quantities and lead times.

**Ridgiduct - Motorway Communications Unsealed Duct**

| Description | Nom. Size | Length (m) | Code | Pack Quantity | Price per length | Price per metre |
|-------------|-----------|------------|------|---------------|------------------|-----------------|
|-------------|-----------|------------|------|---------------|------------------|-----------------|

|                                |     |   |             |    |       |      |
|--------------------------------|-----|---|-------------|----|-------|------|
| <b>Purple unsealed duct</b>    | 94  | 6 | RB94X6PMCP  | 95 | 23.94 | 3.99 |
| Printed Motorway Comms / Power | 100 | 6 | RB100X6PMCP | 85 | 24.82 | 4.14 |



Supplied with 1 coupling fitted per length



Motorway Communications print option is also available made to order, subject to minimum order quantities and lead times.

**RIDGIDUCT - TWIN WALL DUCT**

**Comtite Duct Transit Systems**

| Description              | Description              | Code   | Pack Qty | Price (each) |
|--------------------------|--------------------------|--------|----------|--------------|
| <b>Plugs</b>             | 94mm Duct Plug           | DP94   | 40       | 37.04        |
|                          | 100mm Duct Plug          | DP100  | 40       | 37.04        |
| <b>Grommets**</b>        | Blanking Insert          | DPG0   | 10       | 6.68         |
|                          | 9mm Grommet              | DPG9   | 10       | 6.68         |
|                          | 12mm Grommet             | DPG12  | 10       | 6.68         |
|                          | 14mm Grommet             | DPG14  | 10       | 6.68         |
|                          | 16mm Grommet             | DPG16  | 10       | 6.68         |
|                          | 18mm Grommet             | DPG18  | 10       | 6.68         |
|                          | 21mm Grommet             | DPG21  | 10       | 6.68         |
|                          | 24mm Grommet             | DPG24  | 10       | 6.68         |
|                          | 27mm Grommet             | DPG27  | 10       | 6.68         |
|                          | 9mm Grommet with 4 holes | DPG9X4 | 10       | 6.68         |
| 9mm Grommet with 7 holes | DPG9X7                   | 10     | 6.68     |              |

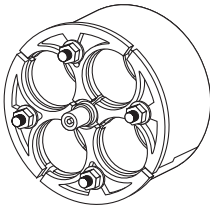

\* Required to attach draw cord if all 4 bores are occupied by cables. \*\* Order grommets in multiples of 10

**Duct Spacers**

| Description              | Duct (ID) | Code     | Pack Qty | Price (each) |
|--------------------------|-----------|----------|----------|--------------|
| <b>2 way Duct Spacer</b> | 94        | RBS110X2 | 50       | 2.01         |
| <b>4 way</b>             | 94        | RBS110X4 | 25       | 4.03         |
| <b>6 way</b>             | 94        | RBS110X6 | 12       | 6.03         |
| <b>2 way Duct Spacer</b> | 100       | RBS118X2 | 50       | 2.01         |
| <b>4 way</b>             | 100       | RBS118X4 | 25       | 4.03         |
| <b>6 way</b>             | 100       | RBS118X6 | 12       | 6.03         |

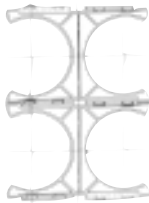

**Ridgiduct - Orange Lighting**

| Description  | ID (mm) | OD (mm) | Length (m) | Code               | Pack Quantity | Price per length | Price per metre |
|--|---------|---------|------------|--------------------|---------------|------------------|-----------------|
| <b>Printed Traffic Signal (TS) or Street Lighting (SL)</b> | 94      | 110     | 6          | RB94X60(TS or SL)  | 95            | 23.94            | 3.99            |
|  | 100     | 118     | 6          | RB100X60(TS or SL) | 85            | 25.02            | 4.17            |
|  | 150     | 178     | 6          | RB150X60(TS or SL) | 36            | 36.63            | 6.10            |

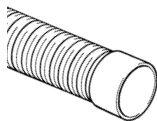

Supplied with 1 coupling fitted per length

Plain ended ducts & other print options are available made to order, subject to minimum order quantities and lead times.

**Ridgiduct - Utilities Ducting**

| Description                       | Nom. Size | Length (m) | Code        | Pack Quantity | Price per length | Price per metre |
|-----------------------------------|-----------|------------|-------------|---------------|------------------|-----------------|
| <b>Water Pipes (Blue)</b>         | 94        | 6          | RB94X6BL    | 95            | 23.98            | 4.00            |
|                                   | 150       | 6          | RB150X6BL   | 36            | 36.63            | 6.10            |
|                                   | 225       | 6          | RB225X6BLPE | 14            | 95.25            | 15.88           |
|                                   | 300       | 6          | RB300X6BLPE | 9             | 149.13           | 24.85           |
| <b>Gas Pipes (Yellow)</b>         | 94        | 6          | RB94X6Y     | 95            | 23.94            | 3.99            |
|                                   | 150       | 6          | RB150X6Y    | 36            | 36.63            | 6.10            |
|                                   | 225       | 6          | RB225X6YPE  | 14            | 94.89            | 15.82           |
|                                   | 300       | 6          | RB300X6YPE  | 9             | 149.13           | 24.85           |
| <b>Telecommunications (Green)</b> | 94        | 6          | RB94X6G     | 95            | 23.94            | 3.99            |
|                                   | 150       | 6          | RB150X6G    | 36            | 36.63            | 6.10            |

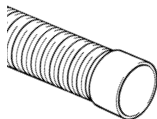

94mm Supplied with 1 coupling fitted per length  
225 & 300mm supplied plain ended.

Order couplings and seals separately if required.

**Gas Pipes (Yellow)**  
Specification for Gas ducting may vary depending upon regulating authority, please check before order placement. Perforated gas ducting available on request.

PLEASE ALLOW 3 DAYS FOR DELIVERY

PLEASE ALLOW 7 DAYS FOR DELIVERY

MADE TO ORDER ONLY

**RIDGIDUCT - TWIN WALL DUCT**

**Scottish Street Lighting Purple Duct and Fittings**

| Description | Nom. Size (mm) | ID (mm) | Code | Price (each) | Price per m |
|-------------|----------------|---------|------|--------------|-------------|
|-------------|----------------|---------|------|--------------|-------------|

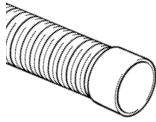

Supplied with 1 coupling fitted per length

**Single Wall Corrugated**

|           |     |    |            |        |      |
|-----------|-----|----|------------|--------|------|
| 100m coil | 60  | 53 | SSL60X100P | 170.81 | 1.71 |
| 40m coil  | 100 | 90 | SSL100X40P | 111.80 | 2.79 |

| Description | Nom. Size (mm) | Code | Pack Qty | Price (each) |
|-------------|----------------|------|----------|--------------|
|-------------|----------------|------|----------|--------------|

|                       |     |          |    |       |
|-----------------------|-----|----------|----|-------|
| <b>Junction Boxes</b> | 100 | SSLJB100 | 10 | 13.98 |
|-----------------------|-----|----------|----|-------|

**Shrouded End Caps**

|       |     |           |    |      |
|-------|-----|-----------|----|------|
| 4-way | 100 | SSLEC4PIN | 10 | 3.78 |
|-------|-----|-----------|----|------|

**Connectors**

|  |     |         |     |      |
|--|-----|---------|-----|------|
|  | 60  | SSLC60  | 150 | 1.44 |
|  | 100 | SSLC100 | 75  | 2.28 |

**Reducers**

|           |        |                |    |      |
|-----------|--------|----------------|----|------|
| Slotted   | 100x60 | SSLR100X60Slot | 75 | 7.54 |
| Unslotted | 100x60 | SSLR100X60     | 75 | 7.54 |

**Ridgiduct - Fittings**

| Description | Code | Pack Qty | Price (each) |
|-------------|------|----------|--------------|
|-------------|------|----------|--------------|

|                            |       |    |      |
|----------------------------|-------|----|------|
| <b>94mm Black Coupling</b> | RBC94 | 10 | 2.54 |
|----------------------------|-------|----|------|

|                             |        |    |      |
|-----------------------------|--------|----|------|
| <b>100mm Black Coupling</b> | RBC100 | 10 | 3.23 |
|-----------------------------|--------|----|------|

|                             |        |    |      |
|-----------------------------|--------|----|------|
| <b>125mm Black Coupling</b> | RBC125 | 10 | 5.21 |
|-----------------------------|--------|----|------|

|                             |        |    |      |
|-----------------------------|--------|----|------|
| <b>150mm Black Coupling</b> | RBC150 | 10 | 4.63 |
|-----------------------------|--------|----|------|

For a sealed 94mm system order SRD94 seals and CRD94 couplings.  
 For a sealed 100mm system order SRD100 seals and CRD100 couplings.  
 For a sealed 150mm system order SRD150 seals and CRD150 couplings.

**Ridgiduct Black Long Radius Drawn Bends**

| Description | Angle | Radius (mm) | Code | Pack Qty | Price (each) |
|-------------|-------|-------------|------|----------|--------------|
|-------------|-------|-------------|------|----------|--------------|

|      |        |     |                |    |      |
|------|--------|-----|----------------|----|------|
| 94mm | 11.25° | 420 | RBDB94X11X0.42 | 10 | 9.42 |
|      | 22.5°  | 420 | RBDB94X22X0.42 | 10 | 9.42 |
|      | 45°    | 420 | RBDB94X45X0.42 | 7  | 9.42 |
|      | 90°    | 420 | RBDB94X90X0.42 | 7  | 9.42 |

|       |        |     |                 |    |       |
|-------|--------|-----|-----------------|----|-------|
| 100mm | 11.25° | 420 | RBDB100X11X0.42 | 10 | 11.15 |
|       | 22.5°  | 420 | RBDB100X22X0.42 | 10 | 11.15 |
|       | 45°    | 420 | RBDB100X45X0.42 | 7  | 11.15 |
|       | 90°    | 420 | RBDB100X90X0.42 | 7  | 11.15 |

|       |        |     |                |   |       |
|-------|--------|-----|----------------|---|-------|
| 125mm | 11.25° | 600 | RBDB125X11X0.6 | 7 | 14.19 |
|       | 22.5°  | 600 | RBDB125X22X0.6 | 7 | 14.19 |
|       | 45°    | 600 | RBDB125X45X0.6 | 4 | 14.19 |
|       | 90°    | 600 | RBDB125X90X0.6 | 3 | 14.19 |

|       |        |     |                 |   |       |
|-------|--------|-----|-----------------|---|-------|
| 150mm | 11.25° | 610 | RBDB150X11X0.61 | 5 | 18.69 |
|       | 22.5°  | 610 | RBDB150X22X0.61 | 5 | 18.69 |
|       | 45°    | 610 | RBDB150X45X0.61 | 4 | 18.69 |
|       | 90°    | 610 | RBDB150X90X0.61 | 3 | 18.69 |

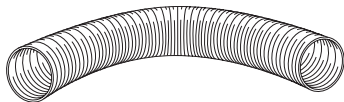

PLEASE ALLOW 3 DAYS FOR DELIVERY

PLEASE ALLOW 7 DAYS FOR DELIVERY

MADE TO ORDER ONLY

## RIDGIDUCT - TWIN WALL DUCT

### Ridgiduct Bends and Accessories

Ridgiduct bends are manufactured from uPVC ducting.

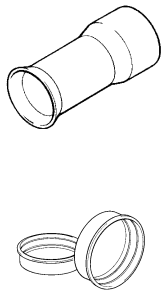
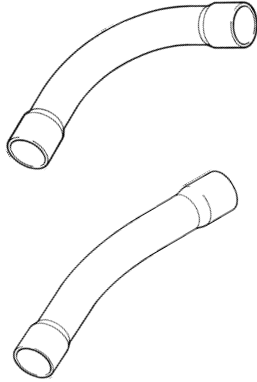

| Description                    | Angle | Radius (m) | Code | Pack Qty       | Price (each) |       |
|--------------------------------|-------|------------|------|----------------|--------------|-------|
| <b>uPVC Double Socket Bend</b> | 100mm | 11.25°     | 2.4  | RBB100X11X2.4  | 1            | 19.40 |
|                                |       | 22.5°      | 2.4  | RBB100X22X2.4  | 1            | 19.40 |
|                                |       | 45°        | 0.45 | RBB100X45X0.45 | 1            | 19.40 |
|                                |       | 90°        | 0.45 | RBB100X90X0.45 | 1            | 19.40 |
|                                | 125mm | 11.25°     | 2.4  | RBB125X11X2.4  | 1            | 27.08 |
|                                |       | 22.5°      | 2.4  | RBB125X22X2.4  | 1            | 27.08 |
|                                |       | 45°        | 0.61 | RBB125X45X0.61 | 1            | 27.08 |
|                                |       | 90°        | 0.61 | RBB125X90X0.61 | 1            | 27.08 |
|                                | 150mm | 11.25°     | 2.4  | RBB150X11X2.4  | 1            | 40.78 |
|                                |       | 22.5°      | 2.4  | RBB150X22X2.4  | 1            | 40.78 |
|                                |       | 45°        | 0.61 | RBB150X45X0.61 | 1            | 40.78 |
|                                |       | 90°        | 0.61 | RBB150X90X0.61 | 1            | 40.78 |

Sealed Ridgiduct bends are available for 100 & 150mm duct.

| Description                          | Size (mm) | Code    | Pack Qty | Price (each) |
|--------------------------------------|-----------|---------|----------|--------------|
| <b>Single Socket Fixed Bellmouth</b> | 94        | RBBM94  | 1        | 5.64         |
|                                      | 100       | RBBM100 | 1        | 5.64         |
|                                      | 125       | RBBM125 | 1        | 9.14         |
|                                      | 150       | RBBM150 | 1        | 11.02        |
| <b>Plastic End Cap</b>               | 94        | RBEC94  | 1        | 2.02         |
|                                      | 100       | EC1059  | 1        | 2.23         |
|                                      | 125       | EC3051  | 1        | 2.67         |
|                                      | 150       | EC1778  | 1        | 5.37         |

\* Made to order and are subject to minimum order quantities and lead times.

## POLYDUCT

### Polyduct - Black Electric Cable Duct

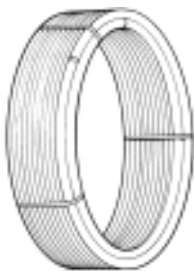

Order Couplers and Seals separately

|                                    | OD (mm) | ID (mm) | Length (m) | Code           | Pack Quantity | Price per length | Price per metre |
|------------------------------------|---------|---------|------------|----------------|---------------|------------------|-----------------|
| <b>Printed Electric Cable Duct</b> | 37      | 32      | 100 coil   | PD3237X100BEPE | 1             | 91.32            | 0.91            |
|                                    | 37      | 32      | 50 coil    | PD3237X50BEPE  | 1             | 46.29            | 0.93            |
|                                    | 37      | 32      | 25 coil    | PD3237X25BEPE  | 1             | 23.70            | 0.95            |
|                                    | 44      | 38      | 100 coil   | PD3844X100BEPE | 1             | 122.20           | 1.22            |
|                                    | 44      | 38      | 50 coil    | PD3844X50BEPE  | 1             | 61.93            | 1.24            |
|                                    | 44      | 38      | 25 coil    | PD3844X25BEPE  | 1             | 31.70            | 1.27            |
|                                    | 60      | 50      | 50 coil    | PD5060X50BEPE  | 1             | 119.79           | 2.09            |
|                                    | 60      | 50      | 25 coil    | PD5060X25BEPE  | 1             | 61.40            | 2.46            |

Other print options are available made to order, subject to minimum order quantities and lead times.

PLEASE ALLOW 3 DAYS FOR DELIVERY

PLEASE ALLOW 7 DAYS FOR DELIVERY

MADE TO ORDER ONLY

**POLYDUCT**

| Polyduct Black Couplings |                           |         |       |          |            |  |
|--------------------------|---------------------------|---------|-------|----------|------------|--|
| Description              | To suit duct measurements |         | Code  | Pack Qty | Price each |  |
|                          | ID (mm)                   | OD (mm) |       |          |            |  |
| <b>Couplings</b>         | 32                        | 37      | PDC32 | 1        | 1.72       |  |
|                          | 38                        | 44      | PDC38 | 1        | 1.75       |  |
|                          | 50                        | 60      | PDC50 | 1        | 2.49       |  |

| Polyduct Orange Lighting           |         |        |            |                       |          |              |
|------------------------------------|---------|--------|------------|-----------------------|----------|--------------|
| Description                        | OD (mm) | ID(mm) | Length (m) | Code                  | Pack Qty | Price (each) |
| <b>Printed Traffic Signal (TS)</b> | 60      | 50     | 6          | PD5060X60(SL or TS)   | 250      | 14.10        |
| <b>Street Lighting (SL)</b>        | 63      | 56     | 6          | PD5663X60(SL or TS)   | 250      | 13.12        |
|                                    | 107     | 100    | 6          | PD100107X60(SL or TS) | 85       | 27.09        |
|                                    | 107     | 97     | 6          | PD97107X60(SL or TS)  | 85       | 28.19        |

| Polyduct Orange Lighting Bends |         |       |             |            |          |              |
|--------------------------------|---------|-------|-------------|------------|----------|--------------|
| Description                    | OD (mm) | Angle | Radius (mm) | Code       | Pack Qty | Price (each) |
| <b>Bends</b>                   | 60      | 45°   | 350         | PDB60X450  | 25       | 5.60         |
|                                | 60      | 90°   | 225         | PDB60X900  | 25       | 5.60         |
|                                | 63      | 45°   | 350         | PDB63X450  | 25       | 5.60         |
|                                | 63      | 90°   | 225         | PDB63X900  | 25       | 5.60         |
|                                | 107     | 45°   | 450         | PDB107X450 | 1        | 9.84         |
|                                | 107     | 90°   | 450         | PDB107X900 | 1        | 9.84         |

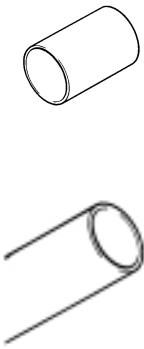

Polyduct is available in all NJUG colours, subject to minimum order quantities, lead times and priced on application.

**RIDGICOIL**

| Ridgicoil - Black Electric Cable Duct |         |         |            |            |                |                 |  |
|---------------------------------------|---------|---------|------------|------------|----------------|-----------------|--|
| Description                           | OD (mm) | ID (mm) | Length (m) | Code       | Price per coil | Price per metre |  |
| <b>Printed Electric Cable Duct</b>    | 40      | 31      | 50         | RC40X50BE  | 60.90          | 1.22            |  |
|                                       | 50      | 40      | 50         | RC50X50BE  | 70.28          | 1.41            |  |
|                                       | 63      | 50      | 50         | RC63X50BE  | 87.46          | 1.75            |  |
|                                       | 75      | 60      | 50         | RC75X50BE  | 123.38         | 2.47            |  |
|                                       | 90      | 71      | 50         | RC90X50BE  | 138.99         | 2.78            |  |
|                                       | 110     | 94      | 50         | RC110X50BE | 187.41         | 3.75            |  |
|                                       | 160     | 140     | 25         | RC160X25BE | 218.65         | 8.75            |  |

Other print options are available made to order, subject to minimum order quantities and lead times. 125mm is made to order only, subject to minimum order quantities and lead times.

  

| Ridgicoil - Purple Motorway Comms.              |         |         |            |              |                |                 |  |
|---|---------|---------|------------|--------------|----------------|-----------------|--|
| Description                                     | OD (mm) | ID (mm) | Length (m) | Code         | Price per coil | Price per metre |  |
| <b>Printed Motorway Communications / Power.</b> | 63      | 50      | 50         | RC63X50PMCP  | 87.46          | 1.75            |  |
|   | 110     | 94      | 50         | RC110X50PMCP | 187.41         | 3.75            |  |

Motorway Communications print and No print options are also available made to order, subject to minimum order quantities and lead times.

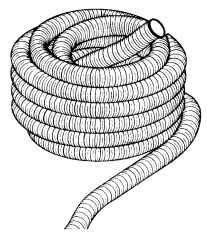

1 coupler supplied per coil

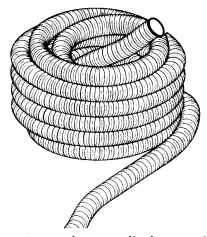

1 coupler supplied per coil

**RIDGICOIL**

**Ridgicoil - Purple Motorway Comms.**

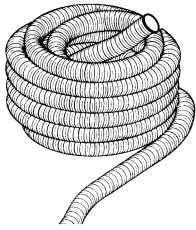

1 coupler supplied per coil

| Description                                     | OD (mm) | ID (mm) | Length (m) | Code         | Price per coil | Price per metre |
|---|---------|---------|------------|--------------|----------------|-----------------|
| <b>Printed Motorway Communications / Power.</b> | 63      | 50      | 50         | RC63X50PMCP  | 87.46          | 1.75            |
|   | 110     | 94      | 50         | RC110X50PMCP | 187.41         | 3.75            |

Motorway Communications print and No print options are also available made to order, subject to minimum order quantities and lead times.

**Ridgicoil - Orange Lighting**

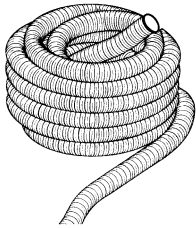

1 coupler supplied per coil

| Description   | OD (mm) | ID (mm) | Length (m) | Code               | Price per coil | Price per metre |
|---|---------|---------|------------|--------------------|----------------|-----------------|
| <b>Printed Traffic Signal (TS) or Street Lighting (SL).</b> | 63      | 50      | 50         | RC63X50(TS or SL)  | 87.46          | 1.75            |
|   | 110     | 94      | 50         | RC110X50(TS or SL) | 187.41         | 3.75            |

90mm & other print options are available made to order, subject to minimum order quantities and lead times. Other sizes made to order.

**Ridgicoil - Utilities**

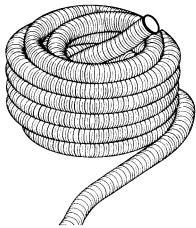

1 coupler supplied per coil

| Description         | OD (mm) | ID (mm) | Length (m) | Code       | Price per coil | Price per metre |
|---------------------|---------|---------|------------|------------|----------------|-----------------|
| <b>Water (Blue)</b> | 50      | 40      | 50         | RC50X50BL  | 70.28          | 1.41            |
|                     | 63      | 50      | 50         | RC63X50BL  | 87.46          | 1.75            |
|                     | 110     | 94      | 50         | RC110X50BL | 187.41         | 3.75            |

\*Made to order, subject to minimum order quantities and lead times.

**Ridgicoil - Utilities**

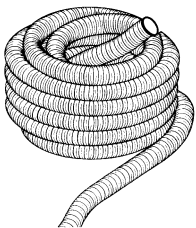

1 coupler supplied per coil

| Description         | OD (mm) | ID (mm) | Length (m) | Code      | Price per coil | Price per metre |
|---------------------|---------|---------|------------|-----------|----------------|-----------------|
| <b>Gas (Yellow)</b> | 50      | 40      | 50         | RC50X50Y  | 70.28          | 1.41            |
|                     | 63      | 50      | 50         | RC63X50Y  | 87.46          | 1.75            |
|                     | 110     | 94      | 50         | RC110X50Y | 187.41         | 3.75            |

\*Made to order, subject to minimum order quantities and lead times.

**Ridgicoil - Utilities**

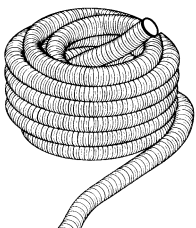

1 coupler supplied per coil

| Description                       | OD (mm) | ID (mm) | Length (m) | Code      | Price per coil | Price per metre |
|-----------------------------------|---------|---------|------------|-----------|----------------|-----------------|
| <b>Telecommunications (Green)</b> | 63      | 50      | 50         | RC63X50G  | 87.46          | 1.75            |
|                                   | 110     | 94      | 50         | RC110X50G | 187.41         | 3.75            |

PLEASE ALLOW 3 DAYS FOR DELIVERY

PLEASE ALLOW 7 DAYS FOR DELIVERY

MADE TO ORDER ONLY

**RIDGICOIL**

**Ridgicoil - Couplings**

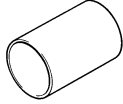

| Description | OD (mm) | Code   | Pack Qty | Price (each) |
|-------------|---------|--------|----------|--------------|
|             | 40      | RCC40  | 10       | 1.61         |
|             | 50      | RCC50  | 10       | 1.76         |
|             | 63      | RCC63  | 10       | 2.24         |
|             | 75      | RCC75  | 10       | 2.99         |
|             | 90      | RCC90  | 10       | 3.06         |
|             | 110     | RCC110 | 10       | 3.37         |
|             | 160     | RCC160 | 10       | 5.93         |

**Ridgicoil - Seals**



| Description | OD (mm) | Code   | Pack Qty | Price (each) |
|-------------|---------|--------|----------|--------------|
|             | 40      | RCS40  | 10       | 1.22         |
|             | 50      | RCS50  | 10       | 1.28         |
|             | 63      | RCS63  | 10       | 1.38         |
|             | 75      | RCS75  | 10       | 1.38         |
|             | 90      | RCS90  | 10       | 1.70         |
|             | 110     | RCS110 | 10       | 1.86         |
|             | 160     | RCS160 | 10       | 5.54         |

**Draw Cords**

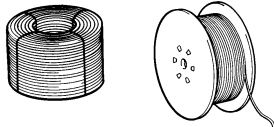

| Description  | Code  | Pallet Qty | Price (each) |
|--|-------|------------|--------------|
| 6mm diameter x 220m Draw Cord  | DC220 | 240        | 11.97        |
| 6mm diameter x 500m Draw Cord (wooden drum)<br>Nominal 5kN breaking strength | DC500 | 108        | 29.16        |

**uPVC SPECIFICATION DUCTING**

**BS4660 Type Duct Non - Sealed (Dimensions Compliant Only)**

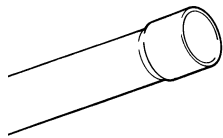

Grey to black in colour as standard. Colours available on request, made to order and subject to minimum order quantities and lead times.

| Description   | Dia (mm)        | W.T.* (mm)   | Code        | Pack Qty        | Price per metre     |
|---|-----------------|--------------|-------------|-----------------|---------------------|
| <b>BS4660 Type Duct Non-Sealed in 6 metre lengths</b> | 110             | 3.2-3.5      | SD110X6B    | 95              | 16.53               |
|   | 160             | 4.1-4.7      | SD160X6B    | 46              | 25.87               |
| <b>Bends</b>  | <b>Dia (mm)</b> | <b>Angle</b> | <b>Code</b> | <b>Pack Qty</b> | <b>Price (each)</b> |
|   | 110             | 11.25°       | SDB110X11   | 1               | 11.65               |
|   | 110             | 22.5°        | SDB110X22   | 1               | 11.65               |
|   | 110             | 45°          | SDB110X45   | 1               | 11.65               |
|   | 110             | 90°          | SDB110X90   | 1               | 11.65               |
|   | 160             | 11.25°       | SDB160X11   | 1               | 28.32               |
|   | 160             | 22.5°        | SDB160X22   | 1               | 28.32               |
|   | 160             | 45°          | SDB160X45   | 1               | 28.32               |
| <b>Couplings</b>                                      | 110             |              | SDC110      | 1               | 2.74                |
|   | 160             |              | SDC160      | 1               | 3.89                |

PLEASE ALLOW 3 DAYS FOR DELIVERY

PLEASE ALLOW 7 DAYS FOR DELIVERY

MADE TO ORDER ONLY

**uPVC SPECIFICATION DUCTING**

**BS4660 Type Duct Sealed (Dimensions Compliant Only)**



Grey to black in colour as standard with other colours available on request.  
\* WT = Wall Thickness

| Description   | Dia (mm)        | W.T.* (mm)   | Code        | Pack Qty        | Price per metre     |
|---|-----------------|--------------|-------------|-----------------|---------------------|
| <b>BS4660 Type Duct Sealed Plain Ended in 6 metre lengths</b> | 110             | 3.2-3.5      | SD110X6BPE  | 95              | 16.53               |
|   | 160             | 4.1-4.7      | SD160X6BPE  | 46              | 25.87               |
| <b>Bends</b>  | <b>Dia (mm)</b> | <b>Angle</b> | <b>Code</b> | <b>Pack Qty</b> | <b>Price (each)</b> |
|   | 110             | 45°          | SDB110X45PE | 1               | P.O.A.              |
|   | 110             | 90°          | SDB110X90PE | 1               | P.O.A.              |
|   | 160             | 45°          | SDB160X45PE | 1               | P.O.A.              |
| <b>Couplings (polypropylene)</b>                              | 160             | 90°          | SDB160X90PE | 1               | P.O.A.              |
|   | 110             |              | UG402B      | 1               | 3.77                |
|   | 160             |              | UG602B      | 1               | 7.94                |

**uPVC GENERAL PURPOSE DUCT**

**uPVC General Purpose Duct and Fittings**

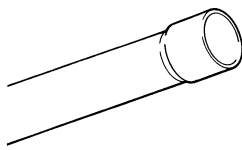

Grey to black in colour for both pipes and fittings.



| Description                              | Dia (inches) | Dia (mm) | W.T. (mm) | Code     | Pack Qty     | Price per length | Price per metre |
|--|--------------|----------|-----------|----------|--------------|------------------|-----------------|
| <b>Ducts in 6 metre Straight Lengths</b> | 2"           | 54       | 1.5-1.7   | GP2X6B   | 400          | 6.53             | 1.09            |
|  | 3"           | 89       | 1.8-2.2   | GP3X6B   | 144          | 9.55             | 1.59            |
|  | 4"           | 114      | 1.8-2.1   | GP4X6B   | 86           | 10.96            | 1.83            |
|  | 6"           | 168      | 2.2-2.9   | GP6X6B   | 36           | 19.93            | 3.32            |
|  | 8"           | 200      | 3.2-3.6   | GP8X6B   | 25           | 63.32            | 10.55           |
| Description                              | Dia (inches) | Dia (mm) | Code      | Pack Qty | Price (each) |                  |                 |
| <b>Bends</b>                             | 2            | 54       | GPB2X11   | 60       | 3.32         |                  |                 |
|  | 2            | 54       | GPB2X22   | 60       | 3.32         |                  |                 |
|  | 2            | 54       | GPB2X45   | 60       | 3.32         |                  |                 |
|  | 2            | 54       | GPB2X90   | 50       | 3.32         |                  |                 |
|  | 3            | 89       | GPB3X11   | 25       | 3.70         |                  |                 |
|  | 3            | 89       | GPB3X22   | 25       | 3.70         |                  |                 |
|  | 3            | 89       | GPB3X45   | 15       | 3.70         |                  |                 |
|  | 3            | 89       | GPB3X90   | 10       | 3.70         |                  |                 |
|  | 4            | 114      | GPB4X11   | 10       | 4.60         |                  |                 |
|  | 4            | 114      | GPB4X22   | 10       | 4.60         |                  |                 |
|  | 4            | 114      | GPB4X45   | 10       | 4.60         |                  |                 |
|  | 4            | 114      | GPB4X90   | 7        | 4.60         |                  |                 |
|  | 6            | 168      | GPB6X11   | 3        | 10.68        |                  |                 |
|  | 6            | 168      | GPB6X22   | 3        | 10.68        |                  |                 |
|  | 6            | 168      | GPB6X45   | 3        | 10.68        |                  |                 |
|  | 6            | 168      | GPB6X90   | 3        | 10.68        |                  |                 |
|  | 8            | 200      | GPB8X11   | 1        | 36.91        |                  |                 |
|  | 8            | 200      | GPB8X22   | 1        | 36.91        |                  |                 |
| 8  | 200          | GPB8X45  | 1         | 36.91    |              |                  |                 |
| 8  | 200          | GPB8X90  | 1         | 36.91    |              |                  |                 |

PLEASE ALLOW 3 DAYS FOR DELIVERY

PLEASE ALLOW 7 DAYS FOR DELIVERY

MADE TO ORDER ONLY

**uPVC GENERAL PURPOSE DUCT**

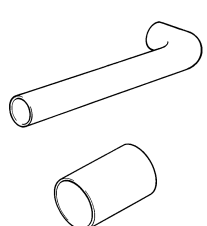
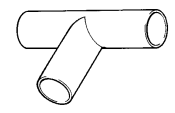
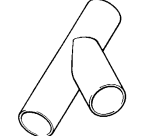
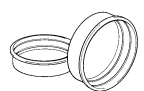
| Description  | Dia (inches) | Dia (mm) | Code     | Pack Qty | Price (each) |
|--|--------------|----------|----------|----------|--------------|
|  <p><b>Hockey Sticks*</b></p> <p><b>Connectors</b></p>  | 2"           | 54       | GPHS2    | 25       | 4.64         |
|  | 2"           | 54       | GPC2     | 10       | 1.46         |
|  | 3"           | 89       | GPC3     | 60       | 2.20         |
|  | 4"           | 114      | GPC4     | 40       | 2.44         |
|  | 6"           | 168      | GPC6     | 15       | 2.71         |
|  <p><b>90° Junctions</b><br/>Manufactured to order and subject to minimum order quantities and lead times</p> | 2"           | 54       | GPJT2X90 | 1        | 8.99         |
|  | 3"           | 89       | GPJT3X90 | 1        | 14.39        |
|  | 4"           | 114      | GPJT4X90 | 1        | 16.16        |
|  | 6"           | 168      | GPJT6X90 | 1        | 26.96        |
|  | 8"           | 206      | GPJT8X90 | 1        | 33.23        |
|  <p><b>45° Junctions</b><br/>Manufactured to order and subject to minimum order quantities and lead times</p> | 2"           | 54       | GPJY2X45 | 1        | 8.99         |
|  | 3"           | 89       | GPJY3X45 | 1        | 14.39        |
|  | 4"           | 114      | GPJY4X45 | 1        | 16.16        |
|  | 6"           | 168      | GPJY6X45 | 1        | 26.96        |
|  | 8"           | 206      | GPJY8X45 | 1        | 33.23        |
|  <p><b>End Caps</b></p>  | 2"           | 54       | GPEC2    | 10       | 0.58         |
|  | 3"           | 89       | GPEC3    | 10       | 0.67         |
|  | 4"           | 114      | GPEC4    | 10       | 0.95         |
|  | 6"           | 168      | GPEC6    | 10       | 1.90         |
|  | 8"           | 206      | GPEC8    | 10       | 9.99         |

\* Made to order and are subject to minimum order quantities and lead times.

**SURETWIN GENERAL PURPOSE TWIN WALL DUCT**

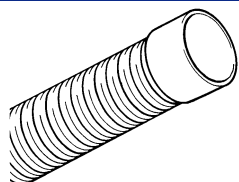
| Suretwin General Purpose Twin Wall Duct and Fittings   |         |         |           |          |                  |                 |
|--|---------|---------|-----------|----------|------------------|-----------------|
| Description  | ID (mm) | OD (mm) | Code      | Pack Qty | Price per length | Price per metre |
|  <p><b>HDPE Twin Wall Ducting in 6 metre lengths</b></p> <p>For fittings please see Ridgiduct section.</p> <p>Suretwin has recently been relaunched for non BBA certified twin wall products meeting the stiffness and normal duty impact requirements of BS EN 50086-2-4. No other provisions of this standard are applicable to Suretwin products.</p> <p>1 coupler supplied per length</p> | 150     | 178     | GPT150X6B | 36       | 30.56            | 5.09            |

**YELLOW PERFORATED GAS DUCT**

| Gas Ducting                         |           |            |             |                  |
|-------------------------------------|-----------|------------|-------------|------------------|
| Description                         | Nom. Size | Length (m) | Code        | Price per length |
| <b>Perforated Gas Duct (Yellow)</b> | 60        | 25         | LD6025YGAS  | 20.97            |
|                                     | 60        | 50         | LD6050YGAS  | 41.92            |
|                                     | 60        | 150        | LD60150YGAS | 126.11           |
|                                     | 100       | 25         | LD10025YGAS | 55.64            |
|                                     | 100       | 50         | LD10050YGAS | 111.29           |

PLEASE ALLOW 3 DAYS FOR DELIVERY

PLEASE ALLOW 7 DAYS FOR DELIVERY

MADE TO ORDER ONLY

**uPVC UTILITY / TELECOMMS / CABLE TV DUCT**

**uPVC Utility Duct and Fittings**

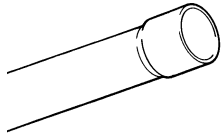

Available in 6 metre lengths, coloured green as standard. Other colours available on request. Minimum order quantities may apply.

| Description                 | OD(mm) | W.T. (mm) | Standard  | Code     | Pack Qty | Price per length | Price per metre |
|-----------------------------|--------|-----------|-----------|----------|----------|------------------|-----------------|
| <b>Green Telecomms Duct</b> | 54     | 1.55-1.70 | -         | TD54X6G  | 400      | 12.81            | 2.14            |
|                             | 96     | 3.0-3.2   | BSEN50086 | TD96X6G  | 121      | 21.53            | 3.66            |
| <b>Grey Duct</b>            | 96     | 3.0-3.2   | BSEN50086 | TD96X6GR | 121      | 21.53            | 3.66            |
| <b>Black Duct</b>           | 96     | 3.0-3.2   | BSEN50086 | TD96X6B  | 121      | 21.88            | 3.65            |

**Bends**



| Description   | Code                    | Pack Qty   | Price (each) |
|---|-------------------------|------------|--------------|
| <b>54mm Green Bends</b>   | TDB54X11G               | 60         | 5.06         |
| 54mm bends also available in grey (GR) and black (B)<br>Please add GR or B to the end of the code | TDB54X22G               | 60         | 5.06         |
|   | TDB54X45G               | 60         | 5.06         |
|   | TDB54X90G               | 50         | 5.06         |
|   | <b>96mm Green Bends</b> | TDB96X11G  | 15           |
|   | TDB96X22G               | 15         | 5.12         |
|   | TDB96X45G               | 15         | 5.12         |
|   | TDB96X90G               | 10         | 5.12         |
|   | <b>96mm Grey Bends</b>  | TDB96X11GR | 15           |
|   | TDB96X22GR              | 15         | 5.12         |
|   | TDB96X45GR              | 15         | 5.12         |
|   | TDB96X90GR              | 10         | 5.12         |
|   | <b>96mm Black Bends</b> | TDB96X11B  | 15           |
|   | TDB96X22B               | 15         | 5.12         |
|   | TDB96X45B               | 15         | 5.12         |
|   | TDB96X90B               | 10         | 5.12         |

**Couplings**

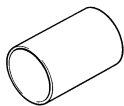

| Description               | Code    | Pack Qty | Price (each) |
|---------------------------|---------|----------|--------------|
| <b>54mm</b>               | TDC54G  | 10       | 1.68         |
| <b>54mm Slip Coupling</b> | TDSC54G | 10       | 1.71         |
| <b>96mm</b>               | TDC96G  | 50       | 2.32         |
| <b>96mm Slip Coupling</b> | TDSC96G | 50       | 3.09         |

**Swept Tees**

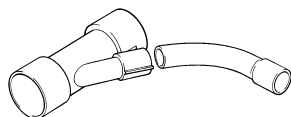

| Description      | Code       | Pack Qty | Price (each) |
|------------------|------------|----------|--------------|
| <b>96 x 54mm</b> | TDJT96X54G | 15       | 4.85         |

PLEASE ALLOW 3 DAYS FOR DELIVERY      PLEASE ALLOW 7 DAYS FOR DELIVERY      MADE TO ORDER ONLY

**uPVC UTILITY / TELECOMMS / CABLE TV DUCT**

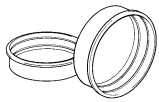
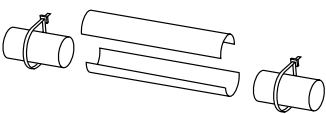
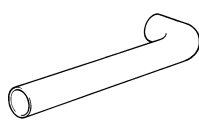
| <b>End Caps</b> (Plastic, inside fitting)  |                     |          |               |              |              |
|--|---------------------|----------|---------------|--------------|--------------|
| Description  | Code                | Pack Qty | Price (each)  |              |              |
|  54mm                 | EC1031              | 10       | 0.97          |              |              |
| 96mm   | EC1055              | 10       | 1.21          |              |              |
| <b>Repair Kits</b>   |                     |          |               |              |              |
| Description  | Standard Length (m) | Code     | Pack Qty      | Price (each) |              |
|  96mm Duct Repair Kit | 0.5                 | DRK096   | 1             | 20.38        |              |
| Other lengths available on request   |                     |          |               |              |              |
| <b>Hockey Sticks</b>   |                     |          |               |              |              |
| Utility Provider   | Nom. Size (mm)      | Colour   | Code          | Pack Qty     | Price (each) |
|  Central Network     | oval                | white    | HSPV019WHITE  | 25           | 5.31         |
| EDF - Eastern  | 39                  | white    | HSPV018WHITE  | 25           | 5.31         |
| NEDL - Northern  | 39                  | white    | HSPV018WHITES | 25           | 5.31         |
| Scottish Power   | 32                  | black    | HSPV032BLACK  | 25           | 5.31         |
| Scottish & Southern Power  | 38                  | black    | HSPV017SEBBLK | 25           | 5.31         |
| Scottish & Southern Power  | 38                  | white    | HSPV017WHITE  | 25           | 5.31         |
| United Utilities   | 32                  | white    | HSPV032WHITE  | 25           | 5.31         |
| Western Power  | 37                  | white    | HSPV016WHITE  | 25           | 5.31         |

**DUCTED ACCESS SYSTEMS**

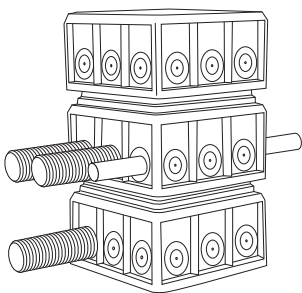
| <b>Ducted Access Boxes, Covers and Frames</b>   |             |                  |       |               |       |           |              |
|---|-------------|------------------|-------|---------------|-------|-----------|--------------|
| Description   | Height (mm) | Box Opening (mm) |       | External (mm) |       | Code      | Price (each) |
|   |             | Width            | Depth | Width         | Depth |           |              |
| <b>ACCESS BOXES</b>   |             |                  |       |               |       |           |              |
|  290 x 275 Single Unit | 320         | 325              | 310   | 390           | 375   | AC2902751 | 23.30        |
| 290 x 275 Double Unit   | 650         | 325              | 310   | 390           | 375   | AC2902752 | 46.60        |
| 290 x 275 Triple Unit   | 985         | 325              | 310   | 390           | 375   | AC2902753 | 69.78        |
| 450 x 300 Single Unit   | 320         | 485              | 335   | 550           | 400   | AC4503001 | 31.05        |
| 450 x 300 Double Unit   | 650         | 485              | 335   | 550           | 400   | AC4503002 | 62.11        |
| 450 x 300 Triple Unit   | 985         | 485              | 335   | 550           | 400   | AC4503003 | 93.17        |
| 450 x 450 Single Unit   | 320         | 470              | 470   | 550           | 550   | AC4504501 | 36.23        |
| 450 x 450 Double Unit   | 650         | 470              | 470   | 550           | 550   | AC4504502 | 72.47        |
| 450 x 450 Triple Unit   | 985         | 470              | 470   | 550           | 550   | AC4504503 | 108.69       |
| 600 x 450 Single Unit   | 320         | 635              | 485   | 700           | 550   | AC6004501 | 47.74        |
| 600 x 450 Double Unit   | 650         | 635              | 485   | 700           | 550   | AC6004502 | 95.47        |
| 600 x 450 Triple Unit   | 985         | 635              | 485   | 700           | 550   | AC6004503 | 143.56       |
| 600 x 600 Single Unit   | 320         | 635              | 635   | 700           | 700   | AC6006001 | 51.76        |
| 600 x 600 Double Unit   | 650         | 635              | 635   | 700           | 700   | AC6006002 | 103.53       |
| 600 x 600 Triple Unit   | 985         | 635              | 635   | 700           | 700   | AC6006003 | 155.28       |

PLEASE ALLOW 3 DAYS FOR DELIVERY

PLEASE ALLOW 7 DAYS FOR DELIVERY

MADE TO ORDER ONLY

**DUCTED ACCESS SYSTEMS**

**Ducted Access Boxes, Covers and Frames**

| Description | Height (mm) | Box Opening (mm) |       | External (mm) |       | Code | Price (each) |
|-------------|-------------|------------------|-------|---------------|-------|------|--------------|
|             |             | Width            | Depth | Width         | Depth |      |              |

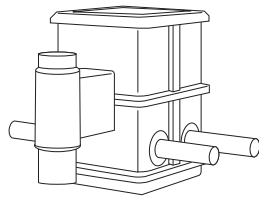

**POLE BOXES**

|                          |     |     |     |     |     |           |       |
|--------------------------|-----|-----|-----|-----|-----|-----------|-------|
| 290 x 275 for 114mm pole | 615 | 325 | 310 | 680 | 400 | PB2902751 | 52.63 |
| 290 x 275 for 140mm pole | 615 | 325 | 310 | 680 | 400 | PB2902752 | 52.63 |
| 450 x 450 for 114mm pole | 605 | 470 | 470 | 875 | 600 | PB4504501 | 67.14 |
| 450 x 450 for 140mm pole | 605 | 470 | 470 | 875 | 600 | PB4504502 | 67.14 |

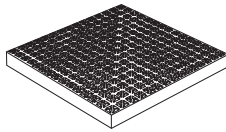

**COMPOSITE COVERS**

|           |  |  |  |  |  |          |        |
|-----------|--|--|--|--|--|----------|--------|
| 290 x 275 |  |  |  |  |  | CC290275 | 28.24  |
| 450 x 300 |  |  |  |  |  | CC450300 | 67.57  |
| 450 x 450 |  |  |  |  |  | CC450450 | 89.87  |
| 600 x 450 |  |  |  |  |  | CC600450 | 111.44 |
| 600 x 600 |  |  |  |  |  | CC600600 | 129.40 |

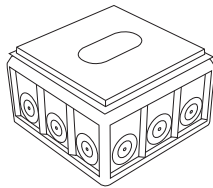

**COMPOSITE COVER FRAMES NON-LOCKING GALVANISED STEEL FRAMES**

|           |  |  |  |  |  |           |       |
|-----------|--|--|--|--|--|-----------|-------|
| 290 x 275 |  |  |  |  |  | CCF290275 | 29.48 |
| 450 x 300 |  |  |  |  |  | CCF450300 | 32.49 |
| 450 x 450 |  |  |  |  |  | CCF450450 | 35.95 |
| 600 x 450 |  |  |  |  |  | CCF600450 | 39.56 |
| 600 x 600 |  |  |  |  |  | CCF600600 | 43.12 |

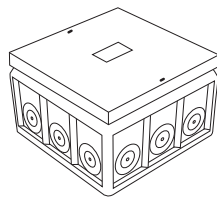

**COMPOSITE COVER FRAMES LOCKING GALVANISED STEEL FRAMES**

|           |  |  |  |  |  |            |       |
|-----------|--|--|--|--|--|------------|-------|
| 290 x 275 |  |  |  |  |  | CCF290275L | 36.68 |
| 450 x 300 |  |  |  |  |  | CCF450300L | 39.68 |
| 450 x 450 |  |  |  |  |  | CCF450450L | 43.12 |
| 600 x 450 |  |  |  |  |  | CCF600450L | 46.73 |
| 600 x 600 |  |  |  |  |  | CCF600600L | 50.33 |

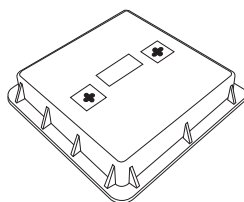

**GALVANISED STEEL COVERS & FRAMES**

|           |  |  |  |  |  |           |        |
|-----------|--|--|--|--|--|-----------|--------|
| 290 x 275 |  |  |  |  |  | GCF290275 | 77.24  |
| 450 x 300 |  |  |  |  |  | GCF450300 | 91.46  |
| 450 x 450 |  |  |  |  |  | GCF450450 | 124.81 |
| 600 x 450 |  |  |  |  |  | GCF600450 | 160.32 |
| 600 x 600 |  |  |  |  |  | GCF600600 | 217.12 |

**DUCTILE IRON COVERS & FRAMES**

|           |  |  |  |  |  |           |        |
|-----------|--|--|--|--|--|-----------|--------|
| 450 x 450 |  |  |  |  |  | DCF450450 | 156.87 |
| 600 x 450 |  |  |  |  |  | DCF600450 | 101.94 |
| 600 x 600 |  |  |  |  |  | DCF600600 | 143.78 |

PLEASE ALLOW 3 DAYS FOR DELIVERY

PLEASE ALLOW 7 DAYS FOR DELIVERY

MADE TO ORDER ONLY

**FIELDcoil LAND DRAINAGE PIPES AND FITTINGS**

BS4962

**Polypropylene Fieldcoil Land Drainage Pipes (Available black only)**

| Description               | Length (m) | Code     | Price per m | Price (each) |
|---------------------------|------------|----------|-------------|--------------|
| <b>60mm perforated</b>    | 25         | SP6025   | 0.82        | 20.42        |
|                           | 50         | SP6050   | 0.82        | 40.82        |
|                           | 150        | SP60150  | 0.82        | 122.82       |
| <b>60mm unperforated</b>  | 150        | SU60150  | 0.82        | 122.82       |
| <b>80mm perforated</b>    | 25         | SP8025   | 1.22        | 30.62        |
|                           | 50         | SP8050   | 1.22        | 61.23        |
|                           | 100        | SP80100  | 1.23        | 122.82       |
| <b>80mm unperforated</b>  | 100        | SU80100  | 1.23        | 122.82       |
| <b>100mm perforated</b>   | 25         | SP10025  | 2.17        | 54.20        |
|                           | 50         | SP10050  | 2.17        | 108.38       |
|                           | 100        | SP100100 | 2.16        | 216.38       |
| <b>100mm unperforated</b> | 100        | SU100100 | 2.16        | 216.38       |
| <b>160mm perforated</b>   | 40         | SP16040  | 5.07        | 202.72       |
| <b>160mm unperforated</b> | 40         | SU16040  | 5.07        | 202.72       |

Refer to page 10 for Types 6, 8, & 9

Sizes shown for land drainage pipes are outside diameters.

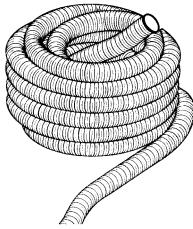

1 coupling supplied per coil.

268mm pipe available from stock. 350mm manufactured to order and subject to lead times.

HDPE land drainage pipes are supplied plain ended. Use CRD225 couplings to join 268mm and CRD300 coupling to join 350mm. See page 3. Couplings should be ordered separately.

**HDPE Land Drainage Pipes (Available black only)**

| Description               | Length (m) | Code    | Price per m | Price (each) |
|---------------------------|------------|---------|-------------|--------------|
| <b>268mm perforated</b>   | 30         | LD26030 | 12.28       | 368.44       |
| <b>268mm unperforated</b> | 30         | UD26030 | 12.28       | 368.44       |
| <b>350mm perforated</b>   | 6          | LD3506  | 20.00       | 120.01       |
| <b>350mm unperforated</b> | 6          | UD3506  | 20.00       | 120.01       |

**Fittings**

| Description      | Size         | Pack Qty | POLYPROPYLENE |              | uPVC  |              |
|------------------|--------------|----------|---------------|--------------|-------|--------------|
|                  |              |          | Code          | Price (each) | Code  | Price (each) |
| <b>Connector</b> | <b>60mm</b>  | 10       | C60           | 1.49         | DC60  | 1.49         |
|                  | <b>80mm</b>  | 10       | C80           | 1.67         | DC80  | 1.67         |
|                  | <b>100mm</b> | 10       | C100          | 1.88         | DC100 | 1.88         |
|                  | <b>125mm</b> | 30       | -             | -            | DC125 | 2.28         |
|                  | <b>160mm</b> | 10       | C160          | 2.59         | DC160 | 2.59         |
|                  | <b>200mm</b> | 8        | -             | -            | DC200 | 9.75         |

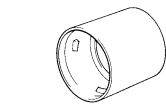

PVC - Blue  
Polypropylene - Black  
HDPE - Black

| Description    | Size         | Pack Qty | POLYPROPYLENE |              | uPVC   |              |
|----------------|--------------|----------|---------------|--------------|--------|--------------|
|                |              |          | Code          | Price (each) | Code   | Price (each) |
| <b>End Cap</b> | <b>60mm</b>  | 10       | HECPP60       | 1.32         | HEC60  | 1.32         |
|                | <b>80mm</b>  | 10       | HECPP80       | 1.67         | HEC80  | 1.67         |
|                | <b>100mm</b> | 10       | HECPP100      | 1.88         | HEC100 | 1.88         |
|                | <b>125mm</b> | 10       | HECPP110      | 2.59         | HEC125 | 2.59         |
|                | <b>160mm</b> | 10       | HECPP160      | 2.34         | HEC160 | 2.34         |
|                | <b>200mm</b> | 10       | -             | -            | HEC200 | P.O.A.       |

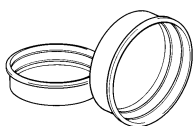

Colours may vary, may be red, blue or green.

PLEASE ALLOW 3 DAYS FOR DELIVERY

PLEASE ALLOW 7 DAYS FOR DELIVERY

MADE TO ORDER ONLY

**LANDCOIL LAND DRAINAGE PIPES AND FITTINGS**

**Outfall Pipe Available in 1.5 metre lengths. (Black or blue state with order)**

Outfall pipes are manufactured to order and subject to lead times.



| Description | Pack Qty | Code   | Price (each) |
|-------------|----------|--------|--------------|
| 60mm        | 10       | HOP60  | 4.00         |
| 80mm        | 10       | HOP80  | 6.00         |
| 100mm       | 10       | HOP100 | 8.81         |
| 125mm       | 10       | HOP125 | 10.39        |
| 160mm       | 5        | HOP160 | 14.05        |



Sizes shown for land drainage pipes are outside diameters.

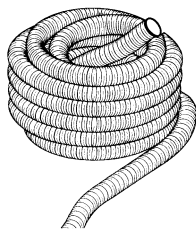

Available in blue. Yellow manufactured to order and subject to minimum order quantities and lead times.

Refer to page 10 for Types 6, 8, & 9

**uPVC Landcoil Land Drainage Pipes**

| Description        | Length (m) | Code      | Price per m | Price (each) |
|--------------------|------------|-----------|-------------|--------------|
| 60mm perforated    | 25         | LD6025B   | 0.75        | 18.69        |
|                    | 50         | LD6050B   | 0.75        | 37.38        |
|                    | 150        | LD60150B  | 0.68        | 101.99       |
| 60mm unperforated  | 150        | UD60150B  | 0.68        | 101.99       |
| 80mm perforated    | 25         | LD8025B   | 1.12        | 28.05        |
|                    | 50         | LD8050B   | 1.12        | 56.10        |
|                    | 100        | LD80100B  | 1.02        | 101.99       |
| 80mm unperforated  | 100        | UD80100B  | 1.02        | 101.99       |
| 100mm perforated   | 25         | LD10025B  | 1.98        | 49.42        |
|                    | 50         | LD10050B  | 1.98        | 98.83        |
|                    | 100        | LD100100B | 1.80        | 179.69       |
| 100mm unperforated | 100        | UD100100B | 1.80        | 179.69       |
| 125mm perforated   | 75         | LD12575B  | 3.24        | 242.81       |
| 125mm unperforated | 75         | UD12575B  | 3.24        | 242.81       |
| 160mm perforated   | 25         | LD16025B  | 4.63        | 115.76       |
|                    | 45         | LD16045B  | 4.21        | 189.39       |
| 160mm unperforated | 45         | UD16045B  | 4.21        | 189.39       |
| 200mm perforated   | 40         | LD20040B  | 8.90        | 356.15       |
| 200mm unperforated | 40         | UD20040B  | 8.90        | 356.15       |

**Land Drainage Fittings**

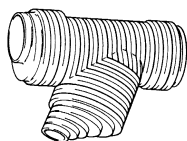

| Description                                      | Code    | Pack Qty | Price (each) |
|--|---------|----------|--------------|
| <b>Junctions</b>                                 |         |          |              |
| 60mm to 60mm diameter blue uPVC Y Junction       | CDJ66   | 140      | 3.15         |
| 80mm to 100mm diameter blue uPVC Multi-Junction  | CDJ10M  | 30       | 4.91         |
| 160mm to 60mm diameter black uPVC Multi-Junction | CDJ160M | 8        | 9.38         |
| 80mm to 100mm diameter black PP Multi-Junction   | CDJ100M | 50       | 4.25         |

**POLYDRY**

**Polydry Horizontal Ducts and Fittings**

| Description                    | Length (m) | Code      | Price per length | Price per metre |
|--------------------------------|------------|-----------|------------------|-----------------|
| 225mm plain ended Polydry duct | 6          | PY225X6PE | 103.31           | 17.22           |
| 300mm plain ended Polydry duct | 6          | PY300X6PE | 134.91           | 22.49           |
| 450mm plain ended Polydry duct | 6          | PY450X6PE | 349.51           | 58.25           |
| 600mm plain ended Polydry duct | 6          | PY600X6PE | 459.56           | 76.59           |



Codes shown are for perforated pipes only. For unperforated pipes insert 'S' in the product code, e.g. PY225X3SPE for unperforated 225mm Polydry pipes in 3m lengths.  
 \*Made to order, subject to minimum order quantities and lead times.

**Polydry Horizontal Fittings**

| Description                      | Size (mm) | Code     | Price (each) |
|----------------------------------|-----------|----------|--------------|
| <b>Polydry Spigot air door</b>   | 225       | PY225SAD | 52.07        |
|                                  | 300       | PY300SAD | 82.45        |
|                                  | 450       | PY450SAD | 97.65        |
|                                  | 600       | PY600SAD | 161.27       |
| <b>Polydry Anti-roll coupler</b> | 225       | PY225C   | 18.43        |
|                                  | 300       | PY300C   | 25.72        |
|                                  | 450       | PY450C   | 47.73        |
|                                  | 600       | PY600C   | 52.07        |
| <b>Polydry End Cap</b>           | 225       | PY225EC  | 14.22        |
|                                  | 300       | PY300EC  | 17.36        |
|                                  | 450       | PY450EC  | 29.27        |
|                                  | 600       | PY600EC  | 54.24        |

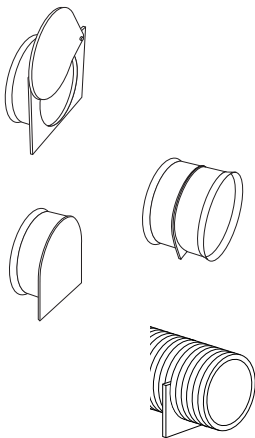

**Polydry Vertical Pedestals**

| Description  | Size (mm)  | Code       | Price (each) |
|--|------------|------------|--------------|
| 1.2m x 300mm lower section to 2 x 1m x 150mm extension pipes | 300 to 150 | PYV3001502 | 167.77       |
| 1.2m x 450mm lower section to 3 x 1m x 150mm extension pipes | 450 to 150 | PYV4501503 | 246.07       |

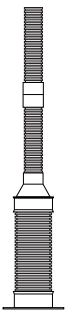

**Polydry Vertical Extensions**

| Description   | Size (mm) | Length (m) | Code     | Price (each) |
|---|-----------|------------|----------|--------------|
| <b>Polydry unperforated extension pipe</b>                            | 150       | 1          | PYV150X1 | 6.48         |
|   | 150       | 2          | PYV150X2 | 12.95        |
| <b>Coupling</b>   | 150       | -          | CRD150   | 5.37         |
| <b>Polydry 240V Fan, single phase, 50Hz for 150mm extension ducts</b> |           |            | VBW7     | 593.91       |
| <b>Polydry 415V Fan, three phase, 50Hz for 200mm extension ducts</b>  |           |            | VBW9     | 813.10       |

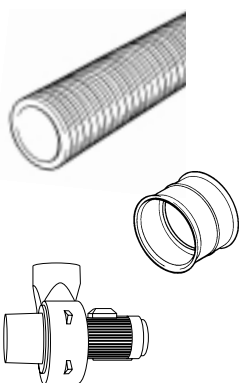

PLEASE ALLOW 3 DAYS FOR DELIVERY

PLEASE ALLOW 7 DAYS FOR DELIVERY

MADE TO ORDER ONLY

**AGRITWIN**

**Agritwin Pipe**

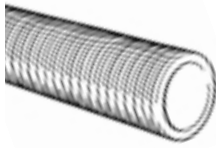

- 150 - 375mm supplied plain ended
- 400 - 600mm supplied integrally socketed
- Order Ridgidrain couplings and fittings separately as required
- Half perforated Agritwin may also be subject to minimum order quantities and lead times

| Nom. Size | Code      | Code Half Perf | Code Perf  | Quantity | Price per length | Price per metre |
|-----------|-----------|----------------|------------|----------|------------------|-----------------|
| 150       | AT150X6PE | AT150X6PEHP    | AT150X6PEP | 36       | 16.29            | 2.71            |
| 225       | AT225X6PE | AT225X6PEHP    | AT225X6PEP | 14       | 44.88            | 7.48            |
| 300       | AT300X6PE | AT300X6PEHP    | AT300X6PEP | 9        | 67.95            | 11.33           |
| 375       | AT375X6PE | -              | AT375X6PEP | 5        | 166.14           | 27.69           |
| 400       | AT400X6   | -              | AT400X6P   | 5        | 233.24           | 38.87           |
| 450       | AT450X6   | -              | AT450X6P   | 1        | 249.90           | 41.65           |
| 500       | AT500X6   | -              | AT500X6P   | 1        | 299.88           | 49.98           |
| 600       | AT600X6   | -              | AT600X6P   | 1        | 395.34           | 65.89           |

**ANCILLARY PRODUCTS**

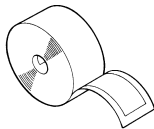
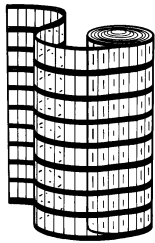

| Description  | Size   | Code        | Pack Qty | Price (each) |
|--|--|-------------|----------|--------------|
| <b>High Visibility Fencing</b><br>Available in orange, blue, yellow & green in 1m x 50m rolls<br>Manufactured to order and subject to minimum order quantities and lead times. | 5.5kg  | FNHVEFN5.5  | 60       | 25.22        |
|  | 8kg  | FNHVEFN8    | 50       | 35.75        |
|  | 10kg   | FNHVEFN10   | 40       | 44.71        |
|  | 12.5kg   | FNHVEFN12.5 | 40       | 49.75        |
|  | 14kg   | FNHVEFN14   | 40       | 54.27        |
| <b>Cable Guard</b><br>Supplied in 10 foot lengths  | 0.5" diameter                                    | CG001X10    | 50       | 6.30         |
|  | 0.75" diameter                                   | CG002X10    | 25       | 7.14         |
|  | 1" diameter                                      | CG003X10    | 25       | 8.73         |
|  | 1.5" diameter                                    | CG004X10    | 10       | 12.35        |
|  | 2" diameter                                      | CG005X10    | 10       | 14.94        |
|  | 2.5" diameter                                    | CG006X10    | 10       | 18.13        |
|  | 3" diameter                                      | CG007X10    | 5        | 29.13        |
| <b>Service Protection Markers MDPE TILE to ESI 12-23</b>   | 40m length 200mm width printed "Electric Cables" | PPTT200     | 30       | 63.40        |
|  | 40m length 150mm width printed "Electric Cables" | PPTT150     | 30       | 50.73        |

Manufactured to order and subject to minimum order quantities and lead times.

**ECO-VAT**

**Eco-Vat Rainwater Harvesting Systems**

**System Selection**

A complete system will include the following items:

- Tank, sized appropriately
- Components to suit, depending on application
  - Irrigation system
  - Gravity system
  - Pressurised system
- Leaf filter appropriate for roof area
- Optional UV Filter
  - for use where additional treatment is required

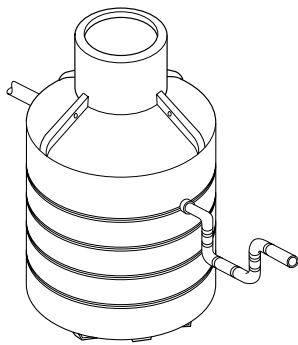

3000 & 5000 litre polyethylene tank.

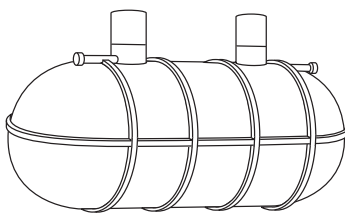

3000 litre and larger GRP tanks.



3000 and 5000 litre systems only

| Description   | Description                                | Code                 | Price (each) |
|---|--|----------------------|--------------|
| <b>Tanks</b>  | 1500 litre primary storage tank            | ECVT1.5              | P.O.A.       |
|   | 3000 litre primary storage tank            | ECVT3                | P.O.A.       |
|   | 5000 litre primary storage tank            | ECVT5                | P.O.A.       |
|   | 3000 litre add on tank                     | ECVT3ADD             | P.O.A.       |
|   | 5000 litre add on tank                     | ECVT5ADD             | P.O.A.       |
|   | 12000 litre GRP primary storage tank       | ECVT12               | P.O.A.       |
|   | 13600 litre GRP primary storage tank       | ECVT13.6             | P.O.A.       |
|   | 15000 litre GRP primary storage tank       | ECVT15               | P.O.A.       |
|   | 18000 litre GRP primary storage tank       | ECVT18               | P.O.A.       |
|   | 22500 litre GRP primary storage tank       | ECVT22.5             | P.O.A.       |
|   | 27000 litre GRP primary storage tank       | ECVT27               | P.O.A.       |
|   | 36000 litre GRP primary storage tank       | ECVT36               | P.O.A.       |
|   | 45000 litre GRP primary storage tank       | ECVT45               | P.O.A.       |
|   | 54000 litre GRP primary storage tank       | ECVT54               | P.O.A.       |
|   | 80000 litre GRP primary storage tank       | ECVT80               | P.O.A.       |
|   | 3000 litre Water storage tank above ground | WST3A                | P.O.A.       |
| 5000 litre Water storage tank above ground                  | WST5A                                      | P.O.A.               |              |
| <b>Boxed Components</b>                                     | 1500 litre irrigation component            | ECV1/1.5             | 836.72       |
|   | 3000 litre irrigation component            | ECV1/3               | 994.48       |
|   | Gravity component                          | ECVG-A               | 2177.54      |
|   | Pressurised component                      | ECVP-A               | 2177.54      |
|   | 5000 litre irrigation component            | ECV1/5               | 1112.63      |
|   | 6000 - 13600 litre irrigation component    | ECV1/6/13.6          | 1184.04      |
|   | 18000 - 80000 litre irrigation component   | ECV1/18/80           | 1222.85      |
|   | <b>Accessories</b>                         | Standard leaf filter | ECVLF        |
| Vortex first flush filter up to 200m <sup>2</sup>           |  | ECVLF100             | 455.22       |
| Vortex first flush filter up to 500m <sup>2</sup>           |  | ECVLF150             | 531.30       |
| Vortex first flush filter up to 3000m <sup>2</sup>          |  | ECVLF300             | 2610.57      |
| 0.5m extension turret for leaf filter to 200m <sup>2</sup>  |  | ECVLF100ET           | 134.43       |
| 0.5m extension turret for leaf filter to 500m <sup>2</sup>  |  | ECVLF150ET           | 134.43       |
| 1m extension turret for leaf filter to 3000m <sup>2</sup> * |  | ECVLF300ET           | 725.57       |
| Extended lifting handle for LF100/LF150                     |  | ECVLFEXTLH**         | 134.43       |
| Extended lifting handle for LF300                           |  | ECVLFEXTLH**         | 162.09       |
| PVC UV filter 8 litres/minute                               |  | ECVUVIP15N           | 728.17       |
| PVC UV filter 19 litres/minute                              |  | ECVUVIP30N           | 964.75       |
| PVC UV filter 54 litres/minute                              |  | ECVUVIP55N           | 1451.05      |
| Stainless steel UV filter 54 litres/minute                  |  | ECVUVIS55N           | P.O.A.       |
| 450 litre header tank                                       |  | ECV450H              | 835.04       |
| Overflow management system                                  |  | ECV/OMS/3            | 897.28       |
| 220 micron floating filter                                  |  | 10005A               | 164.00       |
| Riser for 3000 & 5000l Eco-Vat tank                         |  | UG431                | 25.07        |
| Riser seal  |  | UG488                | 2.61         |
| Marker tape for reclaimed water pipework                    | ECVMT                                      | 5.77                 |              |
| 120 micron inline filter                                    | 10033                                      | 38.23                |              |

**A full list of Eco-Vat spares is available on request. Please contact the technical office.**

\* Length to suit customer specification

\*\* Append either 100, 150 or 300 to the product code



NOTES

A large rectangular area with a blue border, containing numerous horizontal blue lines for writing notes.



NOTES

A large rectangular area with horizontal blue lines, intended for handwritten notes.

# CONDITIONS OF SALE - APRIL 2003

## GENERAL

**1.1** In these conditions "the Company" shall mean Polypipe Civils Limited and "the Products" shall mean all goods and services and associated documentation to be supplied under this Contract. "Writing" includes telex, cable, facsimile transmission, electronic data transfer and comparable means of communication. All quotations are made and all orders are accepted subject to these conditions. All other terms conditions or warranties whatsoever are excluded from the contract or any variation thereof unless expressly accepted by the Company in Writing (order acknowledgments do not constitute such acceptance). In particular, in no circumstances will any conditions of purchase submitted at any time by the Customer be applied to this or any other Contract and any failure by the Company to challenge any such conditions of purchase does not imply acceptance of those conditions of purchase. In the event of a conflict between these conditions and the specific terms of any quotation then the latter shall prevail. Acceptance by the Customer of delivery of the Products shall be deemed to constitute unqualified acceptance of these conditions.

**1.2** Unless otherwise stated herein quotations shall be available for acceptance for a maximum period of 30 days from issue and may be withdrawn at any time by written or oral notice.

**1.3** Any statement or representation (other than in the Company's quotation or order acknowledgement) by the Company its servants or agents upon which the Customer wishes to rely must be set out in Writing and attached to or endorsed on the Customer's order and in any such case the Company may confirm, reject or clarify the point and submit a new quotation. Any statement or representation which is not so confirmed in Writing is followed or acted upon entirely at the Customer's own risk.

**1.4** The contract is between the Company and the Customer as principals; neither the benefit nor the burden is assignable by the Customer without the Company's written consent; the contract may be assigned or subcontracted by the Company.

**1.5** Unless specifically agreed to the contrary all trade terms shall be interpreted in accordance with current INCOTERMS.

**1.6** If, subsequent to any contract of sale which is subject to these conditions, a contract of sale is made with the same Customer without reference to any conditions of sale or purchase, such contract however made shall be deemed to be subject to these conditions or (if different) the standard Conditions of Sale of the Company current at the time when such contract of sale is made.

## ELECTRONIC TRADING

**2.1** If the Company and Customer agree that electronic trading between them shall be a basis for order processing and invoicing then the Standard Interchange Agreement (3rd Edition December 1993 as amended or revised from time to time) of the Electronic Commerce Association (or any successor body or association) shall be incorporated into the contract by reference. If and to the extent of any conflict or inconsistency between these conditions and the Standard Interchange Agreement, the former shall prevail.

**2.2** Electronic orders shall be valid if all the information agreed between the Customer and the Company as being required is properly set out in the agreed format and the order is transmitted by the Customer to the Company by reference to the correct identification code and is received by the Company when collecting its electronic mail from the relevant system.

**2.3** Each valid electronic order will be deemed accepted by the Customer unless the Company communicates rejection of the order to the Customer by electronic or other means (including telephone) within two working days of receipt. Acceptance of an order shall constitute a contract for sale and purchase to which these conditions and the Standard Interchange Agreement shall apply.

## DELIVERY

**3.1** Unless otherwise agreed in Writing by the Company delivery shall be deemed to take place in the case of ex works sales when the Products are made available by the Company for collection by the Customer or its carrier and in all other cases upon delivery by the Company to the agreed mainland UK delivery point airport or port but before the Products are unloaded, which shall be the responsibility of the Customer.

**3.2** The Company shall not be obliged to make delivery unless and until the Company has received all necessary information drawings final instructions and approvals from the Customer and any delays or alterations by the Customer may result in delayed delivery for which the Company shall not be responsible.

**3.3** All dates and periods for delivery are estimated and do not constitute fixed times for delivery by the Company. Unless otherwise expressly agreed in Writing by the Company the Customer shall have no right to damages or to cancel the contract for failure arising from any cause to meet any delivery times given in the contract or subsequently set.

**3.4** Notwithstanding Clause 3.3 the Customer shall be obliged to accept delivery on the date or within the period stated in the quotation or order or acknowledgement or (if none is so stated) in the order or (if none is so stated) one month after the issue or notice in Writing by the Company requiring the Customer to accept delivery. Failure by the Customer either to take delivery or to make payment in respect of any one or more instalments of Products shall entitle the Company to terminate the Contract (such right is without prejudice to any other rights and remedies available to the Company) whether expressly provided for in these Conditions or implied by any rule of law.

**3.5** Where the Customer requests and the Company agrees to postpone delivery or where delivery is otherwise postponed without default by the Company the Customer shall pay upon receipt of written demand from the Company all costs and expenses including a reasonable charge for storage and transportation occasioned thereby and the Customer shall pay for the Products in accordance with these conditions as if the same had been delivered in the ordinary course without reference to the postponement. In addition, the Company shall be entitled to claim interest pursuant to Clause 7.3.2 of these Conditions from the date on which payment would have fallen due, had the Products been delivered in the ordinary course but for the postponement.

**3.6** Unless otherwise expressly agreed in Writing the Company may effect delivery in one or more instalments. Where delivery is effected by instalments each instalment shall be treated as a separate contract governed by these conditions. No delay in the delivery of any instalment of Products or any defect therein shall entitle the Customer to terminate the remainder of the contract.

## RISK AND TITLE

**4.1** Risk of damage to or loss of the Products shall pass to the Customer upon delivery and the Customer is then solely responsible for all loss damage or deterioration to the Products.

**4.2** Title to the Products shall not pass to the Customer until either:

**4.2.1** The Company has received in cash or cleared funds all monies payable (whether or not due) to the Company under this and any other contracts whenever made between the Company and the Customer including contracts made after this contract; or

**4.2.2** When the Company serves on the Customer notice in Writing specifying that title in the Products or any part thereof has passed.

**4.3** Until title has passed to the Customer the Company may require the Customer to deliver up to the Company all products in respect of which the Company has title and if the Customer fails to do so forthwith the Company's officers, employees, representatives or agents shall be entitled to enter upon any premises where such Products are kept for the purposes of recovering the same.

**4.4** Until title to the Products has passed to the Customer pursuant to these conditions it shall possess the Products as fiduciary agent and bailee of the Company and shall store the Products separately from other goods not owned by the Company and shall ensure that they are fully insured on all risks basis and clearly identifiable as belonging to the Company and the Company shall be entitled to enter upon any premises where such Products are kept for the purpose of satisfying itself that this condition is being complied with by the Customer.

**4.5** In the event that the Customer has any contract with any other company under the ultimate control of the parent company that has ultimate control of the Company under which any monies are outstanding (whether or not due) then the Customer shall not (notwithstanding that title would otherwise pass pursuant to Clause 4.2 above) obtain title to the Products or other goods supplied by the Company under this or any other contracts between them until such other company has received in cash or cleared funds all such monies.

## CANCELLATION AND AMENDMENT

**5** No contract can be amended or cancelled except with the Company's approval in Writing and should such approval be given the Customer shall indemnify the Company against any costs, losses or expenses resulting from any cancellation or amendment.

## PRICES

**6.1** Unless otherwise agreed in Writing all prices are net for delivery ex works and VAT and any other applicable taxes are payable in addition. Unless otherwise stipulated by the Company in Writing prices are payable in Sterling or if the Sterling currency shall cease to exist when the contract is made, shall be payable in such currency as replacing the Sterling currency.

**6.2** The Company shall be entitled at any time by giving notice in Writing, before or at the final invoice to make a reasonable adjustment to the price in the event of any alteration in quantity, design or specification requested by the Customer.

**6.3** The Company reserves the right at any time prior to delivery by giving notice in Writing to increase the price if there is an increase in the cost of materials labour transport or utilities or if the costs of the Company are increased by any other factor beyond the reasonable control of the Company.

**6.4** Charges made on the Company's invoice for cases will be credited on their return to the Company's premises carriage paid and in good reusable condition. Cases shown as returnable but not charged on the Company's invoice must be returned to the Company's premises carriage paid and in good re-usable condition otherwise an additional charge will be made in respect of their cost.

**6.5** The Customer shall be liable to the Company for any demurrage costs incurred in the event of vehicles being unduly delayed at the point of delivery.

## TERMS OF PAYMENT

**7.1** Unless otherwise agreed by the Company in Writing, payment shall be made by the last day of the month following the month of invoice and the Company shall be entitled to issue invoices in the month in which the Products are delivered or would have been delivered, save for postponement otherwise than due to default on the part of the Company. Time for payment of the price is of the essence of the contract.

**7.2** No disputes arising under this contract shall serve to prevent payment by the Customer of sums due to the Company to be delayed nor shall disputes interfere with prompt payment in full. The Buyer shall not be entitled to make any deduction from sums owing to the Company by reason of any such dispute.

**7.3** In the event of default in payment by the Customer the Company shall be entitled without prejudice to any other right or remedy:

**7.3.1** To suspend without notice all further deliveries on this or any other contracts between the Company and the Customer;

**7.3.2** To charge interest on a daily basis (after as well as before judgement) on any amount outstanding at the rate of 4% above the Base Rate of Lloyds Bank plc from time to time; and/or

**7.3.3** To serve notice on the Customer requiring immediate payment for all goods supplied by the company under this and all other contracts between them whether or not payment is otherwise due or invoiced.

## SPECIFICATIONS

**8.1** Subject to Clause 8.2 the Products shall in all material respects be of such specification agreed between the Company and the Customer under the contract, or (if not so agreed) shall be generally in all material respects in accordance with any published specification issued by the Company.

**8.2** The Company reserves the right to make changes in dimensions or other specifications of the Products as are required to conform to applicable standards or laws or are otherwise within reasonable limits having regard to the nature of the Products. Dimensions specified by the Company are to be treated as approximate only unless it is specifically agreed in Writing that exact measurements are required.

## LOSS SHORTAGES AND DAMAGE APPARENT ON DELIVERY INSPECTIONS

**9.1** The Customer shall have no claim for loss, shortages or damage on delivery which are or would be apparent on inspection unless the Customer:

**9.1.1** Unpacks and inspects the Products as soon as reasonably practicable after receipt;

**9.1.2** Notifies the Company of any loss, shortages or damage (otherwise than by a qualified signature on the delivery note) within ten working days of receipt; and

**9.1.3** Demonstrates to the satisfaction of the Company that such loss, shortages or damage occurred prior to delivery.

**9.2** The Customer shall have no rights in respect of loss shortages or damage unless the Company is given a reasonable opportunity to inspect the Products and investigate any complaint before any use of or alteration to or interference with the Products.

**9.3** On a valid complaint made in accordance with this Clause the Customer shall be entitled (in the case of notified shortages) to receive within a reasonable time a delivery of Products equivalent to the shortfall and (in the case of defects) to repairs to or replacements for the affected Products or at the Company's option a credit for the price thereof but the Company shall have no further liability whatsoever. If a complaint of loss shortages or damage on delivery is not made to the Company in accordance with this Clause 9 then the Products shall be deemed to be delivered complete and undamaged in accordance with the contract and the Customer shall be bound to pay for the same accordingly.

**9.4** Loss shortages or damage in a delivery or any instalment delivery shall not be a ground for termination of the contract or the remainder of the contract (as the case may be).

## WARRANTY

**10.1** The Company warrants that Products which do not comply with either Clause 8.1 or Sections 13 to 15 of the Sale of Goods Act 1979 (as amended by the Sale and Supply of Goods Act 1994) or are shown to have been defective at delivery as a result of faulty design workmanship or materials (other than free-issue materials), shall either be repaired or replaced or that, at the Company's option, a credit or refund for the price thereof shall be given provided always that:

**10.1.1** The Company receives written notice of the defect within 12 months of delivery;

**10.1.2** No alteration to or interference with the Products takes place before the Company is given access to the Products to inspect and test the same;

**10.1.3** The defect does not consist of a loss shortage or damage to which Clause 9 is expressed to apply;

**10.1.4** The defect does not arise by reason of a design specification or instruction given by the Customer;

**10.1.5** The Customer has not defaulted in its obligation to make payment of the contract price for the Products;

**10.1.6** The defect shall not be attributable to incorrect storage or use of the Products by the Customer.

**10.2** The benefit of Clause 10.1 shall only extend to Products or parts not manufactured by the Company to the extent that the Company has equivalent recourse against the manufacturer or supplier thereof.

**10.3** The Customer shall indemnify the Company in respect of loss or damage arising from any use made of Products after the Customer became or ought reasonably to have been aware of a defect.

**10.4** In the event of a valid claim being made in accordance with Clause 10.1:

**10.4.1** The Customer shall be bound to accept repaired or replacement Products or at the Company's option credit or payment and shall not be entitled to terminate the contract;

**10.4.2** If the Company does not repair or replace Products within 60 days or such longer time as may be reasonable then the Customer's sole remedy shall be an entitlement to full credit or repayment in respect of the defective Products; and the Company shall be under no further liability in respect of any loss or damage arising from the defect or from any delay before repair replacement credit or refund is effected.

## LIABILITY

**11.1** The Company does not exclude liability arising under Section 12 of the Sale of Goods Act 1979 (good title) (as amended by the Sale and Supply of Goods Act 1994) or for death or personal injury caused by its negligence as defined in the Unfair Contract Terms Act 1977.

**11.2** Save as provided under Clauses 9, 10 and 11.1 the Company shall have no liability to the Customer in connection with or arising from any defect or failure in the Products or otherwise due to the quality condition suitability durability safety or any other aspect or feature of the Products. Save for death or personal injury attributable to the proven negligence of the Company, the Company's liability, whether in respect of one claim or in the aggregate, shall not exceed the contract price payable under this contract for the supply of Products to be provided under it. The Customer acknowledges that the limitation of the Company's liability is reasonable in all the circumstances and the Customer agrees that it is its own responsibility to insure adequately to cover any loss or damage in excess of the aforesaid limit of the Company's liability. Subject to reaching agreement on terms, the Company and the Customer may determine an increased level of liability which is to be accepted in Writing by the Company to cover, in particular specific types of loss or damage which both parties reasonably foresee and anticipate.

**11.3** In Clause 11.2 the term "liability" means any form of liability whatsoever including but not limited to liability in misrepresentation and under contract common law equity and any statutory provision whether or not based on negligence or breach of any express or implied duty to act with care or skill.

**11.4** Notwithstanding any other provisions of these conditions the Customer shall have no claim against the Company in respect of any loss other than strictly direct losses (meaning for these purposes the increased costs of purchasing products from a third party or the cost of remedial repair work) and specifically consequential, financial economic loss whether direct or indirect including but not limited to any incidental costs of dismantling fitting or other ancillary work required in connection with the provision of a repair or replacement, any loss of production profits contracts loss of use or anticipated savings and any claims made against the Customer by any third party are excluded even if reasonably foreseeable.

**11.5** To the extent that any liability of the Company is expressed to be limited or excluded by these conditions the Customer shall indemnify the Company in respect thereof.

## CONFIDENTIAL INFORMATION ETC

**12** All drawings documents records computer software and other information supplied by the Company are supplied on the express understanding that copyright is reserved to the Company and that the Customer will not without written consent of the Company either give away loan exhibit or sell the same or extracts therefrom or copies thereof or use the same in any way except in connection with the Products in respect of which they are issued.

## PATENT INDEMNITIES

**13.1** If the Customer is subject to a claim or threatened with any action alleging that the Products in the form supplied infringe any patent copyright design right or other intellectual property rights then provided that the Customer promptly informs and fully co-operates with the Company and if requested allows the Company to conduct and defend the proceedings on the Customer's behalf, the Company will indemnify the Customer against any award or damages for infringement made in any such action by a court or other competent body against the Customer. Further, if the Products are infringing the Customer agrees that the company shall have the option at its own expense either to modify the Products so that they do not infringe or to replace the Products with a non-infringing substitute or to procure for the Customer the right for the Customer to continue its use of the Products or to repurchase the Products from the Customer at the price paid by the Customer less an allowance for the use made thereof.

**13.2** The Company shall have no liability in respect of claims for infringement or alleged infringement of third parties patent or other intellectual property rights arising from the manufacture or supply of the Products to the Customer's instructions or in accordance with design plans or specifications given by the Customer and the Customer shall indemnify the Company against all losses damages expenses costs or other liability arising from such claims.

## CUSTOMER'S DRAWINGS

**14** The Customer shall be solely responsible for ensuring that all drawings information advice and recommendations provided or given to the Company by the Customer or its agents, servants consultants or advisers are accurate correct and suitable. Examination or consideration by the Company of such drawings information advice or recommendations shall not result in any liability on the part of the Company.

## COMPANY LITERATURE

**15** The information contained in the advertising sales technical and other literature issued by the Company may be relied upon to be accurate in the exact circumstances in which it is expressed otherwise any illustrations performance details examples of installations and methods of assembly and all other information and data in such literature are based on experience and upon trials under test conditions and are provided for general guidance only. No such information or data shall form part of the contract unless it is specifically referred to in the quotation or order acknowledgement or the Customer shall have complied in respect thereof with Clause 1.3.

## TERMINATION

**16.1** Without prejudice to any other rights or remedies of the Company it shall be entitled in any of the following circumstances to terminate (in whole or in part) this and any other contract whenever made between the Company and the Customer and/or to suspend deliveries and/or to receive upon demand payment of all monies payable under any such contracts whether or not otherwise due:

**16.1.1** The Customer made or proposes any voluntary arrangement with its creditors or becomes subject to an administration order or becomes bankrupt or goes into liquidation;

**16.1.2** An encumbrance takes possession or a receiver is appointed of any of the property or assets of the Customer;

**16.1.3** The Customer becomes unable to satisfy its debts as they fall due or cease, or threatens to cease to carry on business;

**16.1.4** The Company reasonably believes that any of the events mentioned above or any equivalent or similar event under any relevant laws to which the Customer or any connected person is subject has or may occur;

**16.1.5** The Customer or any connected person commits any breach of this or any other contract whenever made between the Customer and the Company.

## FORCE MAJEURE

**17.1** The Company shall be excused performance of its obligations whilst and if affected by act of God governmental restriction condition or control, any act done or not done pursuant to a trade dispute whether such dispute involves its employees or not, default by suppliers of the Company, shortage of materials or by any other act matter or thing beyond its reasonable control including failure by the other party to carry out anything required for performance of the contract.

**17.2** In the event that the Company does not perform its obligations by reason of any of the causes referred to in Clause 17.1 within six months after the time for performance then the Company may by written notice terminate the contract without liability save that the Customer shall pay for any Products delivered or completed at the time of termination.

## TOOLS

**18** Any tools (such as jigs, dies, etc) which the Company may construct or acquire specifically in connection with the Products shall, notwithstanding any charges the Company may make for them, be and remain the Company's sole and unencumbered property and in the Company's possession and control without restriction.

## FREE-ISSUE MATERIALS

**19** Free-issue material shall be insured by and remain at the risk of the Customer at all times and the Company shall be indemnified by the Customer against any loss damage injury or expense whatsoever arising directly or indirectly therefrom and the company shall not be liable for loss of or damage to any such materials during fabrication by the Company or sub-contractor employed by the Company or whilst on the premises of the Company or of any sub-contractor or in transit to or from the premises of the Company or of any such sub-contractor provided that the Company may at its sole discretion make a contribution towards the replacement costs of such materials.

**19.2** An allowance for material lost on process scrap is (where applicable) included in the contract price and no such losses shall be the subject of any claim by the Customer or contribution by the Company.

**19.3** Where materials are supplied by or on behalf of the Customer to the Company the Customer shall be responsible to ensure that the material is of satisfactory quality and is fit for its purpose and shall indemnify the Company against any loss damage injury or expenses whatsoever arising directly or indirectly from any fault in or incorrect specification of the said materials.

## CONSUMER PROTECTION ACT 1987

**20.1** Where the Customer purchases the Products for use or incorporation with any composite products to be assembled produced processed packed or supplied by the Customer or for resale or supply ancillary to any such composite products or other products supplied by the Customer then:

**20.1.1** The Customer shall forthwith on demand produce for inspection by the Company copies of all written instructions information and warnings to be supplied by the Customer in relation thereto provided nevertheless that such inspection or right to inspect shall not give rise to any responsibility or liability on the part of the Company; and

**20.1.2** The Customer shall indemnify the Company against any losses costs and damages that the Company may suffer or incur in the event any claim is made against the Company in relation thereto if the Products did not comprise the defective element thereof or were rendered defective by reason of actions or omissions of the Customer (including without limitation the supply of defective free-issue materials) or were rendered defective by reason of instructions or warnings given or omitted by the Customer or other reseller.

**20.2** For the purpose of Clause 20.1 the term "defective" shall be interpreted in accordance with the definition contained in Part 1 of the Consumer Protection Act 1987.

## HEALTH & SAFETY

**21** The Customer agrees to pay due regard to any information supplied by the Company relating to the use for which the Products are designed or have been tested or concerning conditions necessary to ensure that they will be safe and without risk to health at all times when they are being set, used, cleaned, serviced or maintained by any person and the Customer undertakes to take such steps as may be specified by such information or otherwise necessary to ensure that as far as is reasonably practicable the Products will be safe and without risk to health at all times as mentioned above.

## LAW AND JURISDICTION ETC

**21.1** The Contract shall be governed and interpreted exclusively according to the Laws of England. The parties hereby agree to submit to the exclusive jurisdiction of the English courts provided that the Company may at its option take proceedings in the courts of the state in which the Customer is domiciled including action to obtain any remedy (including injunctive relief). In the case of any order for the export of Products, the Schedule to the Uniform Law on International Sales Act 1967 shall not in any circumstances apply to the Contract and neither shall the limits imposed by the Unfair Contract Terms Act 1977 on the extent to which liability can be excluded or limited.

**21.2** No waiver of or delay or failure by the Company to exercise any rights or remedies shall prejudice or preclude any future or further exercise thereof.

**21.3** If any provision of these conditions shall be held invalid or unenforceable in whole or in part then the unaffected provisions shall remain in full force and effect. Headings appear for convenience only and shall not affect the Construction of these conditions.

**21.4** If the Contract includes the supply of services and no general conditions of the company relating specifically to the supply of services are made applicable to such services then these conditions shall mutatis mutandis apply to such services as they would apply to Products and in such event Clause 10.1 will be deemed to include a reference to Sections 3 to 5 of the Supply of Goods and Services Act 1982 (as amended), either in addition to or in place of the reference to Sections 13 to 15 of the Sale of Goods Act 1979 (as amended) as may be appropriate. For the avoidance of doubt the following provisions apply where the Company supplies services to the Customer in accordance with Clause 22.4.

**22.1** The Company's obligation to provide the services is in any event conditional upon payment of the agreed price for the services. Any default or delay in payment according to the terms agreed between the Company and the Customer shall entitle the Company at its option to decline to perform or decline to continue to perform its obligations hereunder but without thereby incurring any liability to the Customer.

**22.2** Save to the extent that by reason of negligence on the part of the Company in the performance of the services which results in death or personal injury (which the Company does not limit or exclude) the Company's liability under the contract shall be limited to the amount of charges paid to the Company in return for the services and in particular the Company accepts responsibility only for direct and unavoidable loss or damage arising from any negligence in the provision of services and in particular all other types of loss whether economic, financial, indirect or consequential and whether reasonably foreseeable or not are excluded to the fullest extent permitted by law.

**22.3** The Customer shall lend all such reasonable assistance to the Company in the performance of the services as the Company shall reasonably require.

**22.4** The Customer shall indemnify and keep the Company, its employees, agents and contractors indemnified at all times from and against any loss or damage or injury caused to persons or property in the course of the provision of the services where such loss or damage arises by reason of the Customer's negligence or negligence of persons under the control of the Customer.

**22.5** The company acknowledges and agrees that if due to the act or omission of the Customer, the company is not able, having attended at the Customer's premises to perform the services, the Company shall be entitled to claim reasonable additional costs and expenses from the Customer occasioned by any resulting delay in the provision of the services.

**22.5.1** In cases for the sale or supply of Products overseas, the following additional provisions shall apply unless otherwise stipulated in writing by the Company:

**22.5.1.1** The Customer shall be solely responsible for obtaining all necessary import authorisations, the payment of any applicable import taxes, duties or imposts and the Company shall be under no obligation to give the Customer the notice specified in Section 32(3) of the Sale of Goods Act 1979 (or any re-enactment thereof).

**22.5.2** Quotations issued in a currency other than Sterling may at the Company's option, unless otherwise agreed in Writing, be subject to amendment in the event of fluctuations in the applicable exchange rate prior to the date of invoice;

**22.5.3** Payment in respect of Products for export is due on the date specified by the Company at the date when the Contract is made, in the currency stated in the invoice and in accordance with the method of payment stipulated by the Company. All costs incurred by the Company in connection with the designated particular method of payment shall be met by the customer.

## ORDERS & INFORMATION

### POLYPIPE CIVILS DIVISION

Polypipe Civils Limited Head Office  
Union Works, Bishop Meadow Road, Loughborough, Leicestershire, LE11 5RE  
Tel: 01509 615100 Fax: 01509 610215

### POLYPIPE CIVILS LTD SALES OFFICE

Tel: 01509 615102 London / Home Counties / East Anglia  
Tel: 01509 615110 Utilities / North West / North East / Ireland  
Tel: 01509 615133 Scotland  
Tel: 01509 615125 South West / Midlands / Wales  
Tel: 01509 615101 Customer Care  
Tel: 01509 615150 Technical Support line  
Fax: 01509 615205 Technical Fax line  
Tel: 01509 615126 Estimating  
Fax: 01509 615153 Estimating Fax line

Fax sales enquiries and orders to: 01509 265945  
E-mail sales enquiries: [sales@polypipецivils.co.uk](mailto:sales@polypipецivils.co.uk)

### POLYPIPE CIVILS LTD SALES OFFICE - SCOTLAND

2410 London Road, Mount Vernon, Glasgow, G32 8XZ  
Tel: 0141 778 8822 Fax: 0141 778 2703

### HYDROTUB POLYPIPE S.A.S

Z.A. des Sablons, 13 Chemin des Petits Eboulis - 77230 Dammartin en Goële,  
France  
Tel: (00 33) 1 64 02 52 42 Fax: (00 33) 1 64 02 54 34

### POLYPIPE GROUP HEAD OFFICE

Broomhouse Lane, Edlington, Doncaster, DN12 1ES  
Tel: 01709 770000 Fax: 01709 770001



[enquiries@polypipецivils.co.uk](mailto:enquiries@polypipецivils.co.uk)  
[www.polypipецivils.co.uk](http://www.polypipецivils.co.uk)

